

## VISUAL MANAGEMENT

**DIN Formate  
und Legendenzeichen**

40

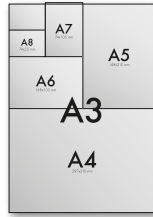

**Sichttaschen**

42



**Kanban-Covers**

44



**Etikettenhalter**

46



**Regal Kennzeichnung**

52



**Haken**

52



**Magnetische oder klebende  
Etikettenhalter**

54



**Magneten**

56

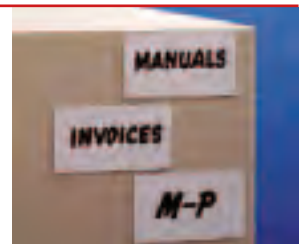

**Kanban System**

58



**Infotafeln und Tabellen**

58

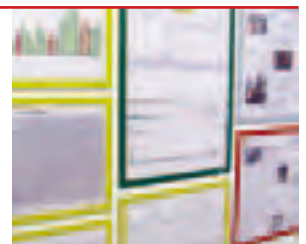

**Bodenmarkierung**

62



**Info-Rahmen**

68



# DIN-FORMATE

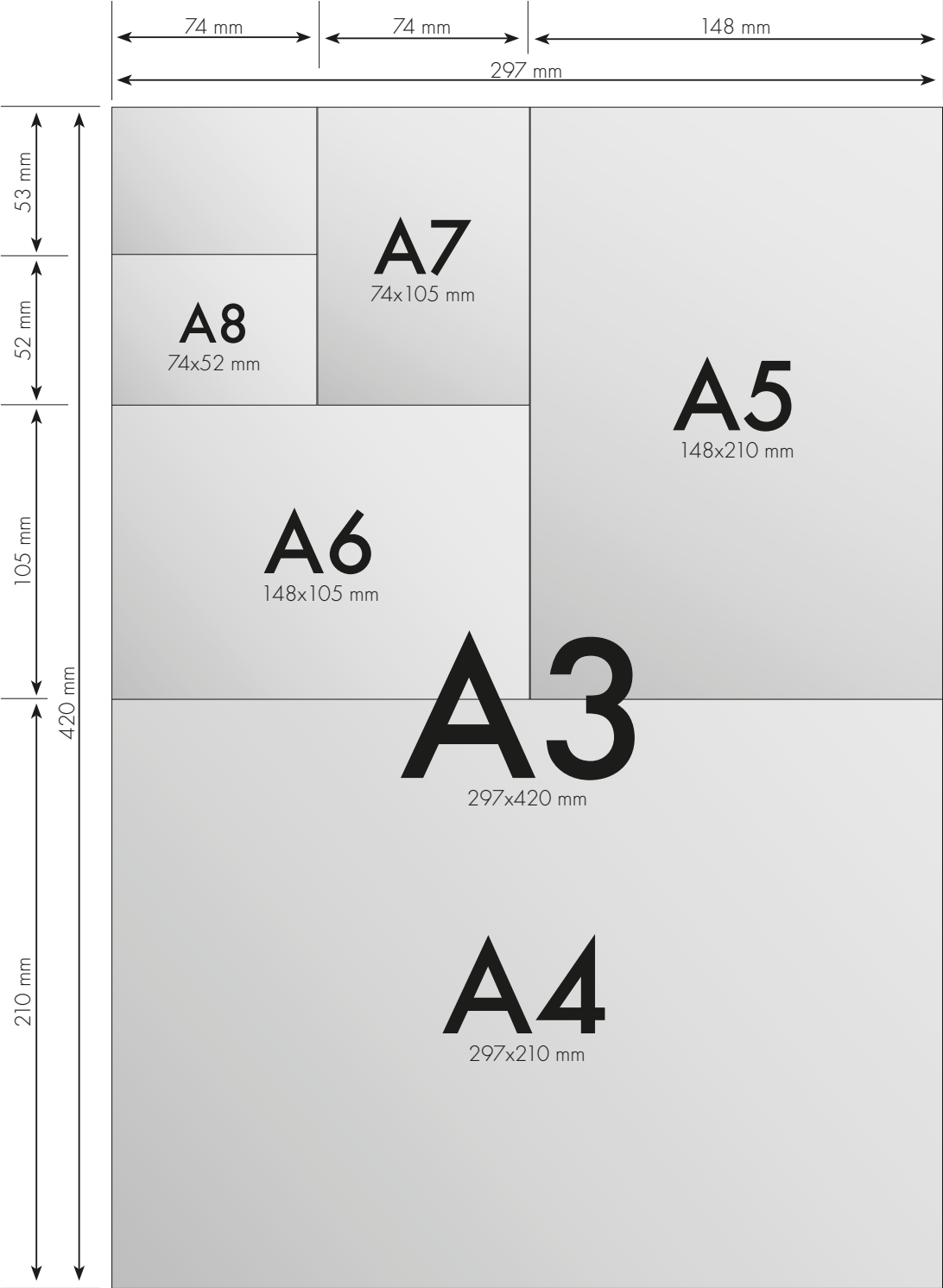

# LEGENDENZEICHEN



Personalisierbar

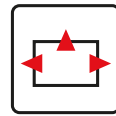

Obere/seitliche Einfügung



Neutral

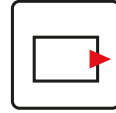

Seitliche Einfügung von rechts

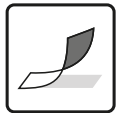

Kle bend

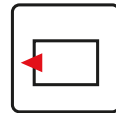

Seitliche Einfügung von links



Magnetisch

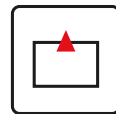

Obere Einfügung



Nach Wunsch kürzbar

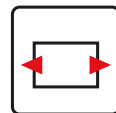

Seitliche Einfügung



Resistent



Beschriftbar



Anti-Kratzer

# FARBELEGENDE

01 Rot

05 Blau

08 Orange

02 Grau

06 Weiß

09 Schwarz

03 Gelb

07 Violett

10 Fluoreszierend

04 Grün

# SICHTTASCHEN

## Sichttasche mit Haken



Vorderseite

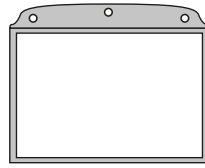

Standard Ausführung

Rückseite

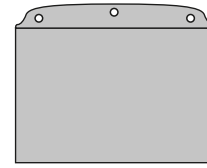

Standard Ausführung

Haken

Siehe S. 52



Packung: 50 Stk.

42

## Klebende Sichttasche



Vorderseite

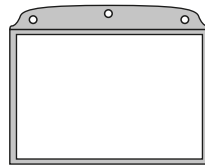

Rückseite A

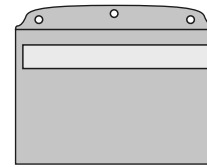

1 klebende Streife  
h. 25 mm

Rückseite B

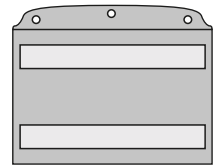

2 klebende Streifen  
h. 25 mm



Packung: 50 Stk.

## Magnetische Sichttasche



Vorderseite

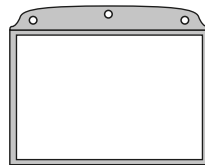

Rückseite A

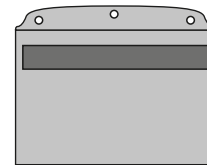

1 Magnet h. 25 mm

Rückseite B

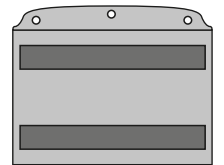

2 Magneten h. 25 mm



Packung: 50 Stk.

## Magnetic Disc Sichttasche



Vorderseite

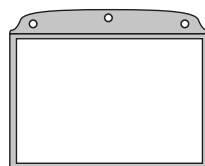

Rückseite A

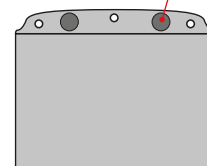

2 Neodymmagneten

Rückseite B

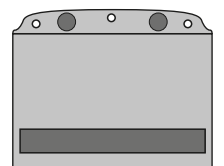

Spezielle Ausführung mit  
klebender Streife



Packung: 50 Stk.

# FORMATE UND FARBEN

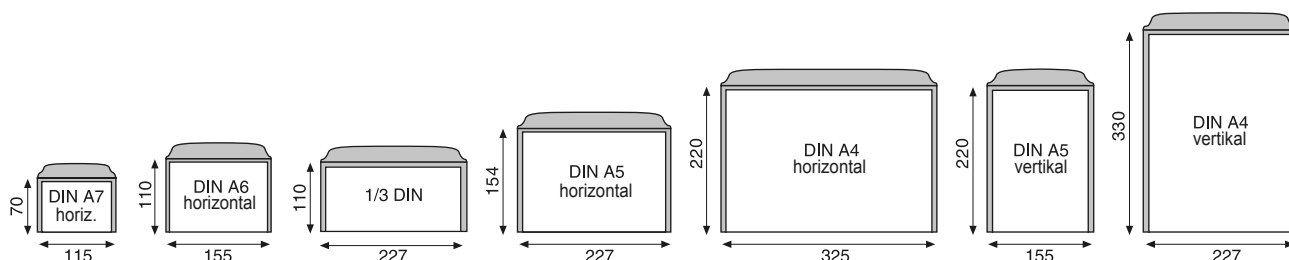

DIN Format	DIN A7 horiz.	DIN A6 horiz.	1/3 DIN horiz.	DIN A5 horiz.	DIN A4 horiz.	DIN A5 vert.	DIN A4 vert.	
Code	<b>ETFN-A7O</b>	<b>ETFN-A6O</b>	<b>ETFN-1/3O</b>	<b>ETFN-A5O</b>	<b>ETFN-A4O</b>	<b>ETFN-A5V</b>	<b>ETFN-A4V</b>	
€/Packung								
Farbcode			01	02	03	04	05	06

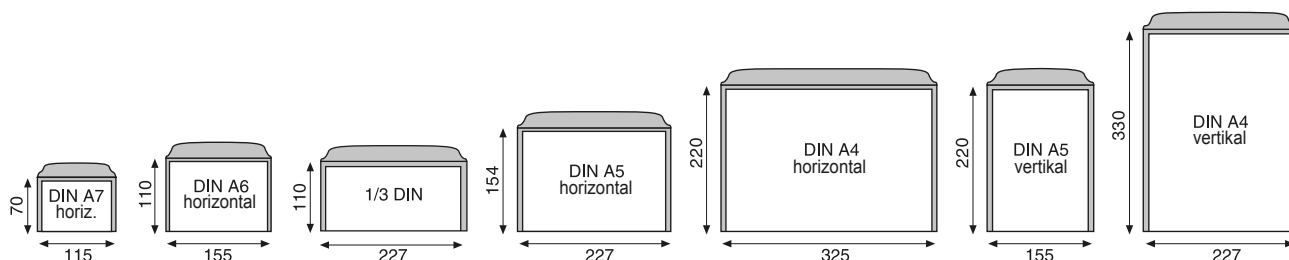

DIN Format	DIN A7 horiz.	DIN A6 horiz.	1/3 DIN horiz.	DIN A5 horiz.	DIN A4 horiz.	DIN A5 vert.	DIN A4 vert.	
Code 1 Streife	<b>ETFA-A7O</b>	<b>ETFA-A6O</b>	<b>ETFA-1/3O</b>	<b>ETFA-A5O</b>	<b>ETFA-A4O</b>	<b>ETFA-A5V</b>	<b>ETFA-A4V</b>	
€/Packung								
Code 2 Streifen	<b>ETF2A-A7O</b>	<b>ETF2A-A6O</b>	<b>ETF2A-1/3O</b>	<b>ETF2A-A5O</b>	<b>ETF2A-A4O</b>	<b>ETF2A-A5V</b>	<b>ETF2A-A4V</b>	
€/Packung								
Farbcode			01	02	03	04	05	06

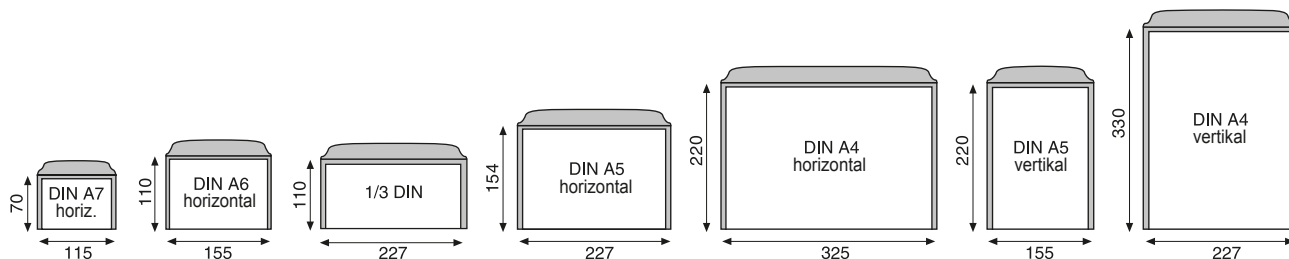

DIN Format	DIN A7 horiz.	DIN A6 horiz.	1/3 DIN horiz.	DIN A5 horiz.	DIN A4 horiz.	DIN A5 vert.	DIN A4 vert.	
Code 1 Magneten	<b>ETFM-A7O</b>	<b>ETFM-A6O</b>	<b>ETFM-1/3O</b>	<b>ETFM-A5O</b>	<b>ETFM-A4O</b>	<b>ETFM-A5V</b>	<b>ETFM-A4V</b>	
€/Packung								
Code 2 Magneten	<b>ETF2M-A7O</b>	<b>ETF2M-A6O</b>	<b>ETF2M-1/3O</b>	<b>ETF2M-A5O</b>	<b>ETF2M-A4O</b>	<b>ETF2M-A5V</b>	<b>ETF2M-A4V</b>	
€/Packung								
Farbcode			01	02	03	04	05	06

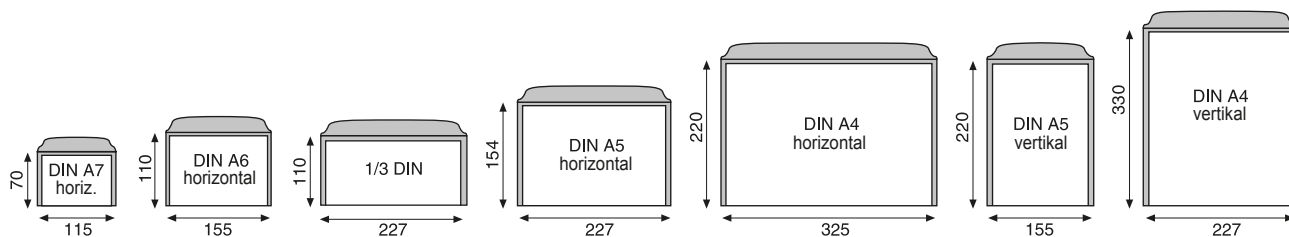

DIN Format	DIN A7 horiz.	DIN A6 horiz.	1/3 DIN horiz.	DIN A5 horiz.	DIN A4 horiz.	DIN A5 vert.	DIN A4 vert.	
Code 2 Magneten	<b>ETFSM-A7O</b>	<b>ETFSM-A6O</b>	<b>ETFSM-1/3O</b>	<b>ETFSM-A5O</b>	<b>ETFSM-A4O</b>	<b>ETFSM-A5V</b>	<b>ETFSM-A4V</b>	
€/Packung								
Code spez. Ausführung	<b>ETF2SM-A7O</b>	<b>ETF2SM-A6O</b>	<b>ETF2SM-1/3O</b>	<b>ETF2SM-A5O</b>	<b>ETF2SM-A4O</b>	<b>ETF2SM-A5V</b>	<b>ETF2SM-A4V</b>	
€/Packung								
Farbcode			01	02	03	04	05	06

# KANBAN-COVERS

## Klebendes Kanban-Cover



Vorderseite



Rückseite

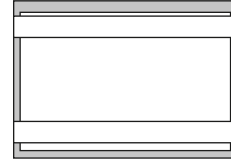

Seite



Packung: 10 Stk.

44

## Kanban-Cover zum Überhängen für Plastik-Kästen



Vorderseite

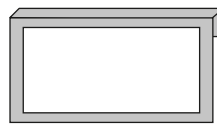

Rückseite A

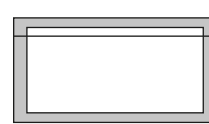

Seite

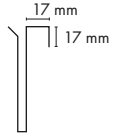

Auf Anfrage:  
Kanban-Cover für jede Art Kasten

Packung: 10 Stk.

## Kanban-Cover für Kartonagen



Vorderseite

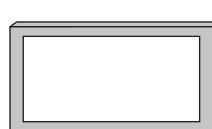

Rückseite A

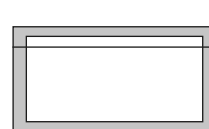

Seite

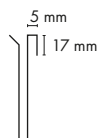

Packung: 10 Stk.

## ET-CLIP Kanban-Cover



Vorderseite



Rückseite

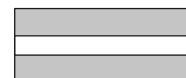

Seite



1 klebende Streife



Packung: 100 Stk.

# FORMATE

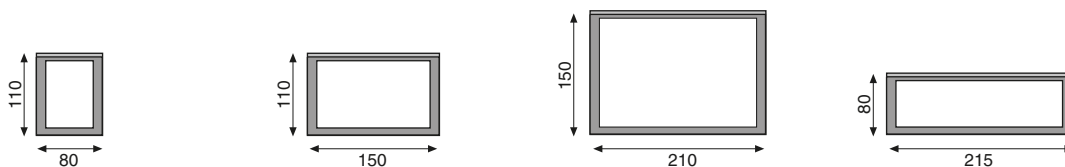

DIN Format	DIN A7 horiz.	DIN A6 horiz.	DIN A5 horiz.	1/3 DIN horiz.
Code	<b>ET2A80-110</b>	<b>ET2A150-110</b>	<b>ET2A150-210</b>	<b>ET2A80-215</b>
€/Packung				

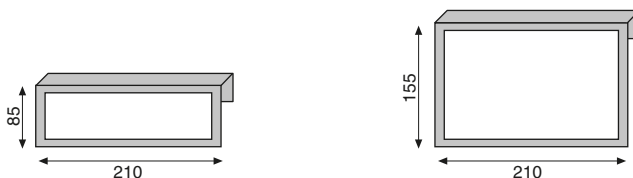

DIN Format	1/4 DIN horiz.	DIN A5 horiz.
Code Stand. Ausführung	<b>ETS85-210</b>	<b>ETS155-210</b>
€/Packung		



DIN Format	1/4 DIN horiz.	DIN A5 horiz.
Code	<b>ETV85-210</b>	<b>ETV155-210</b>
€/Packung		



Abmessungen (mm)	31x75	31x1340
Code	<b>ET-CLIP75</b>	<b>ET-CLIP1340</b>
€/Packung		



# KANBAN-COVERS

## KLT Kanban-Cover



Vorderseite



Rückseite



Packung: 50 Stk.

## 46 EBOX Kanban-Cover



Vorderseite



Rückseite



Packung: 50 Stk.

## Kartoneinlagen

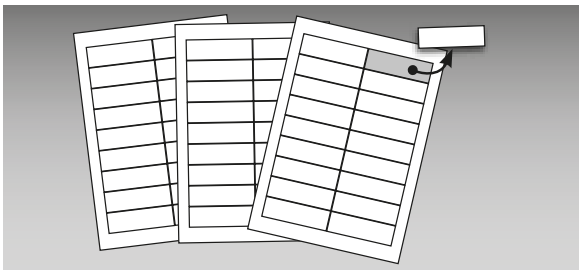

Verwendbar mit jedem Drucker.  
Ideal zum Etikettieren.



Packung: 10 Stk.

# ETIKETTENHALTER

## Etikettenhalter für große Behälter



Vorderseite

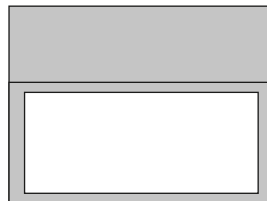

Rückseite

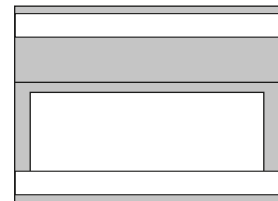

Seite



Packung: 50 Stk.



## FORMATE UND FARBEN

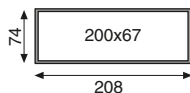

DIN Format	74x208					
Code	<b>KAN-KLT</b>					
€/Packung						
Farbcode	01	02	03	04	05	06

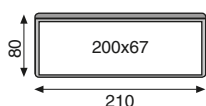

DIN Format	80x210					
Code	<b>KAN-EBOX</b>					
€/Packung						
Farbcode	01	02	03	04	05	06

Abmessungen (mm)	20x75	20x100	20x150	25x75	25x100	25x150	27x75	27x100	27x150	38x75	38x100	38x150
Code	<b>ET20-75</b>	<b>ET20-100</b>	<b>ET20-150</b>	<b>ET25-75</b>	<b>ET25-100</b>	<b>ET25-150</b>	<b>ET27-75</b>	<b>ET27-100</b>	<b>ET27-150</b>	<b>ET38-75</b>	<b>ET38-100</b>	<b>ET38-150</b>
N° Kartoneinlagen/Bogen	28	28	14	22	22	11	20	20	10	14	14	7
N° Bögen/Packung	10	10	10	10	10	10	10	10	10	10	10	10
€/Packung												

Abmessungen (mm)	47x75	47x100	47x150	50x100	50x150	50x200	50x300	50x600	67x100	67x150	67x200	67x300	67x600
Code	<b>ET47-75</b>	<b>ET47-100</b>	<b>ET47-150</b>	<b>ET50-100</b>	<b>ET50-150</b>	<b>ET50-200</b>	<b>ET50-300</b>	<b>ET50-600</b>	<b>ET67-100</b>	<b>ET67-150</b>	<b>ET67-200</b>	<b>ET67-300</b>	<b>ET67-600</b>
N° Kartoneinlagen/Bogen	12	12	6	10	5	5	Auf Anfrage		8	4	4	Auf Anfrage	
N° Bögen/Packung	10	10	10	10	10	10			10	10			
€/Packung													

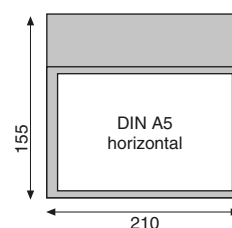
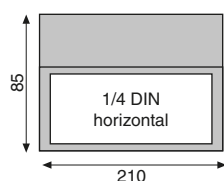

DIN Format	1/4 DIN horiz.	DIN A5 horiz.
Code Standard Ausführung	<b>ETA2AH85-210</b>	<b>ETA2AH155-210</b>
€/Packung		

# ETIKETTENHALTER

## Etikettenhalter für Metall-Draht Ø 5mm



Vorderseite

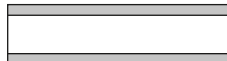

Rückseite



Seite



Packung: 25 Stk.

## 48 C-Design Etikettenhalter



Vorderseite



Rückseite A

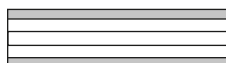

Mit klebender Streife

Rückseite B

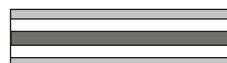

Mit Magnet

Seite



Packung: 25 Stk.

## Etikettenhalter für Rohrbaukastensysteme



Vorderseite

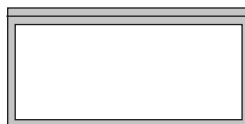

Rückseite

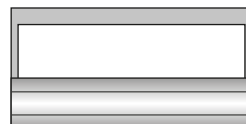

Seite



Packung: 25 Stk.

## Etikettenhalter für Aluminium-Baukastensysteme



Vorderseite

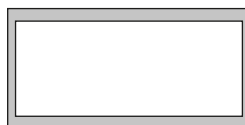

Rückseite



Seite

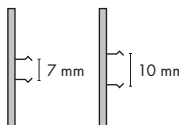

Packung: 25 Stk.

# FORMATE

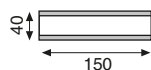

Abmessungen (mm)	<b>40x150</b>
Code	<b>AAS40-150</b>
€/Packung	

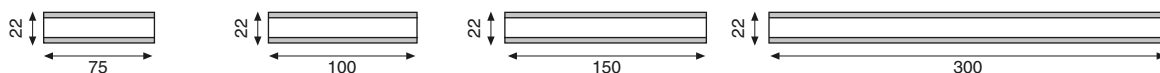

Abmessungen (mm)	<b>22x75</b>	<b>22x100</b>	<b>22x150</b>	<b>22x300</b>
Code klebendes Etikettenhalters	<b>EH22-75</b>	<b>EH22-100</b>	<b>EH22-150</b>	<b>EH22-300</b>
€/Packung				
Code magnetisches Etikettenhalters	<b>EHM22-75</b>	<b>EHM22-100</b>	<b>EHM22-150</b>	<b>EHM22-300</b>
€/Packung				

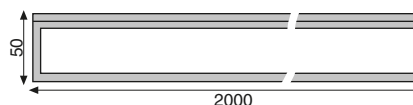
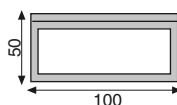

Abmessungen (mm)	<b>50x100</b>	<b>50x2000</b>
Code	<b>ET0016-100</b>	<b>ET0016-2000</b>
€/Packung		

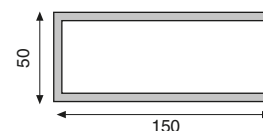
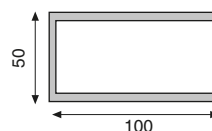
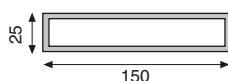
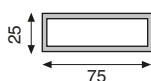

Abmessungen (mm)	<b>25x75</b>	<b>25x150</b>	<b>50x100</b>	<b>50x150</b>
Code	<b>SLH25-75</b>	<b>SLH25-150</b>	<b>SLH50-100</b>	<b>SLH50-150</b>
€/Packung				

## Klebender Etikettenhalter für Regalwände



Vorderseite



Rückseite A

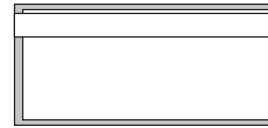

1 klebende Streife

Rückseite B

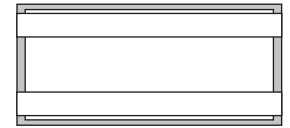

2 klebende Streifen



Packung: 100 Stk.

### FORMATE

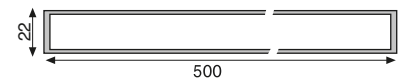
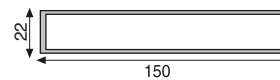
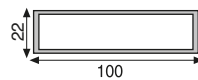
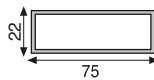

Abmessungen mm	22x75	22x100	22x150	22x500
Code 1 klebende Streife	<b>ETA22-75</b>	<b>ETA22-100</b>	<b>ETA22-150</b>	<b>ETA22-500</b>
€/Packung				
Code 2 klebende Streifen	<b>ET2A22-75</b>	<b>ET2A22-100</b>	<b>ET2A22-150</b>	<b>ET2A22-500</b>
€/Packung				

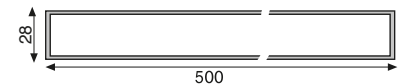
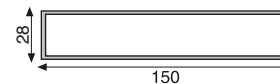
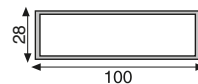
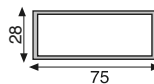

Abmessungen mm	28x75	28x100	28x150	28x500
Code 1 klebende Streife	<b>ETA28-75</b>	<b>ETA28-100</b>	<b>ETA28-150</b>	<b>ETA28-500</b>
€/Packung				
Code 2 klebende Streifen	<b>ET2A28-75</b>	<b>ET2A28-100</b>	<b>ET2A28-150</b>	<b>ET2A28-500</b>
€/Packung				

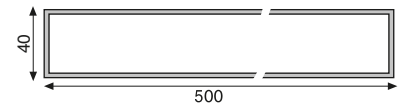
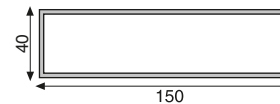
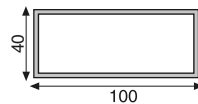
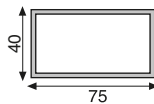

Abmessungen mm	40x75	40x100	40x150	40x500
Code 1 klebende Streife	<b>ETA40-75</b>	<b>ETA40-100</b>	<b>ETA40-150</b>	<b>ETA40-500</b>
€/Packung				
Code 2 klebende Streifen	<b>ET2A40-75</b>	<b>ET2A40-100</b>	<b>ET2A40-150</b>	<b>ET2A40-500</b>
€/Packung				

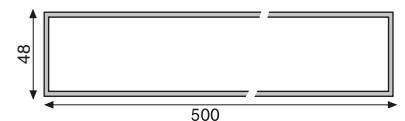
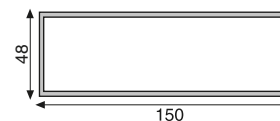
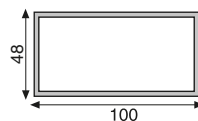
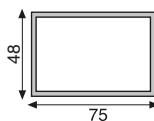

Abmessungen mm	48x75	48x100	48x150	48x500
Code 1 klebende Streife	<b>ETA48-75</b>	<b>ETA48-100</b>	<b>ETA48-150</b>	<b>ETA48-500</b>
€/Packung				
Code 2 klebende Streifen	<b>ET2A48-75</b>	<b>ET2A48-100</b>	<b>ET2A48-150</b>	<b>ET2A48-500</b>
€/Packung				

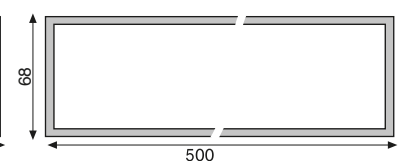
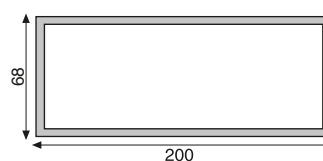
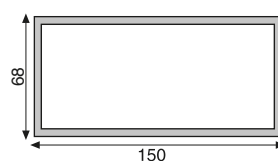
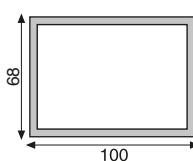

Abmessungen mm	68x100	68x150	68x200	68x500
Code 1 klebende Streife	<b>ETA68-100</b>	<b>ETA68-150</b>	<b>ETA68-200</b>	<b>ETA68-500</b>
€/Packung				
Code 2 klebende Streifen	<b>ET2A68-100</b>	<b>ET2A68-150</b>	<b>ET2A68-200</b>	<b>ET2A68-500</b>
€/Packung				

## Magnetischer Etikettenhalter für Regalwände



Vorderseite



Rückseite A



1 Magnet

Rückseite B



2 Magneten



Packung: 100 Stk.

### FORMATE

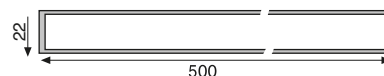
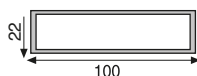
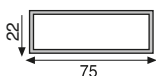

Abmessungen mm	22x75	22x100	22x150	22x500
Code 1 Magnet	<b>ETM22-75</b>	<b>ETM22-100</b>	<b>ETM22-150</b>	<b>ETM22-500</b>
€/Packung				
Code 2 Magneten	<b>ET2M22-75</b>	<b>ET2M22-100</b>	<b>ET2M22-150</b>	<b>ET2M22-500</b>
€/Packung				

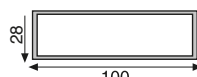
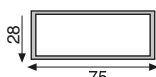

Abmessungen mm	28x75	28x100	28x150	28x500
Code 1 Magnet	<b>ETM28-75</b>	<b>ETM28-100</b>	<b>ETM28-150</b>	<b>ETM28-500</b>
€/Packung				
Code 2 Magneten	<b>ET2M28-75</b>	<b>ET2M28-100</b>	<b>ET2M28-150</b>	<b>ET2M28-500</b>
€/Packung				

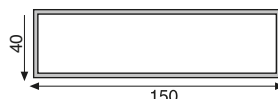
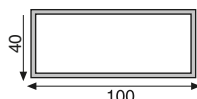
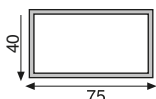

Abmessungen mm	40x75	40x100	40x150	40x500
Code 1 Magnet	<b>ETM40-75</b>	<b>ETM40-100</b>	<b>ETM40-150</b>	<b>ETM40-500</b>
€/Packung				
Code 2 Magneten	<b>ET2M40-75</b>	<b>ET2M40-100</b>	<b>ET2M40-150</b>	<b>ET2M40-500</b>
€/Packung				



Abmessungen mm	48x75	48x100	48x150	48x500
Code 1 Magnet	<b>ETM48-75</b>	<b>ETM48-100</b>	<b>ETM48-150</b>	<b>ETM48-500</b>
€/Packung				
Code 2 Magneten	<b>ET2M48-75</b>	<b>ET2M48-100</b>	<b>ET2M48-150</b>	<b>ET2M48-500</b>
€/Packung				

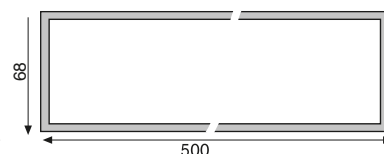
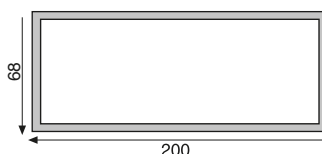
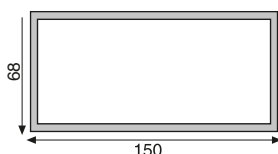
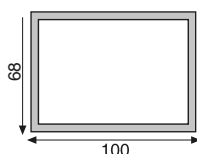

Abmessungen mm	68x100	68x150	68x200	68x500
Code 1 Magnet	<b>ETM68-100</b>	<b>ETM68-150</b>	<b>ETM68-200</b>	<b>ETM68-500</b>
€/Packung				
Code 2 Magneten	<b>ET2M68-75</b>	<b>ET2M68-100</b>	<b>ET2M68-150</b>	<b>ET2M68-500</b>
€/Packung				

# REGAL KENNZEICHNUNG

## ID-SC

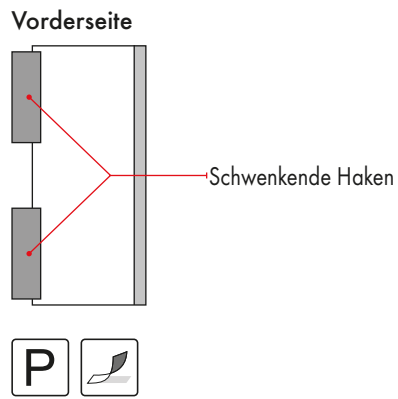

Packung: 10 Stk.

52

# Haken

## Gripper

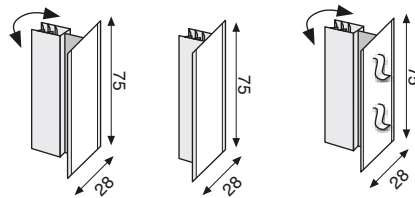
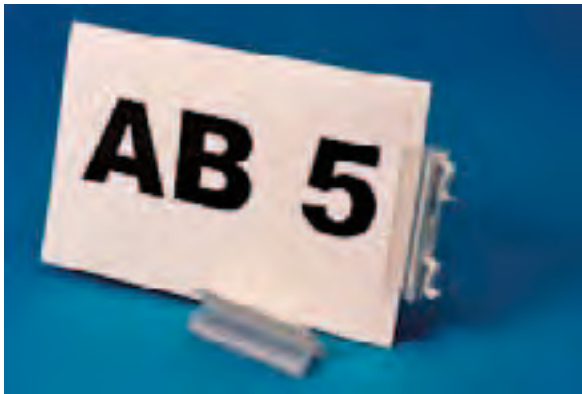

Packung: 10 Stk.

## Haken für Sichttaschen

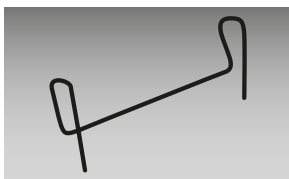

GN-01

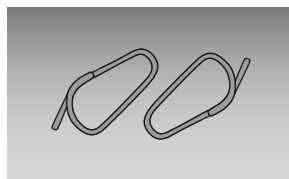

GN-02



GN-03



GN-04



GN-05

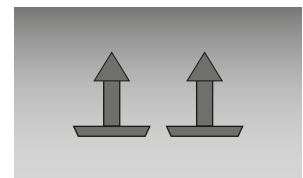

GN-06

# FORMATE UND FARBEN

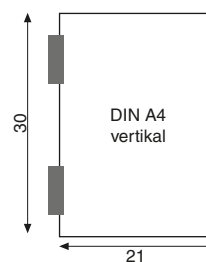
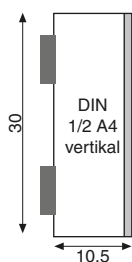

DIN Format	DIN 1/2 A4 vertikal	DIN A4 vertikal
Code	<b>ID-SC-1/2A4</b>	<b>ID-SC-A4</b>
€/Packung		
Farbcode	<span style="color: red;">01</span> <span style="color: grey;">02</span> <span style="color: yellow;">03</span> <span style="color: green;">04</span> <span style="color: blue;">05</span> <span style="color: grey;">06</span>	

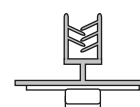

Artikel	Flexibles klebendes Gripper	Festes klebendes Gripper	Gripper mit Haken
Code	<b>GR-01</b>	<b>GR-02</b>	<b>GR-03</b>
€/Packung			

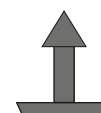
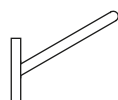

Code	<b>GN-01</b>	<b>GN-02</b>	<b>GN-03</b>	<b>GN-04</b>	<b>GN-05</b>	<b>GN-06</b>
Packung	50 Stk.	50 Stk.	100 Stk.	100 Stk.	50 Stk.	100 Stk.
€/Packung						



# MAGNETISCHE ODER KLEBENDE ETIKETTENHALTER

## Magnetische oder klebende Label Color

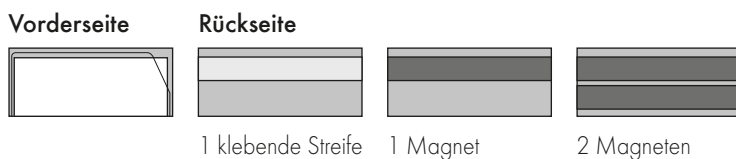

Packung: 50 Stk.

54

## Magnetische oder klebende Label Up



Packung: 50 Stk.

## Magnetische oder klebende Label Long

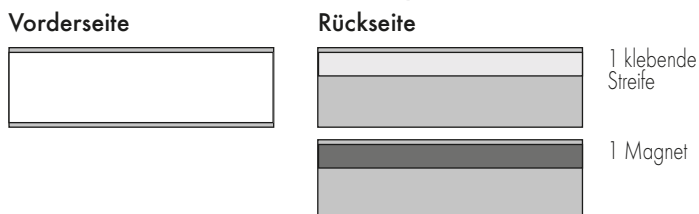

Packung: 10 Stk.

## Palette Kanban



Packung: 10 Stk.

## FORMATE UND FARBEN

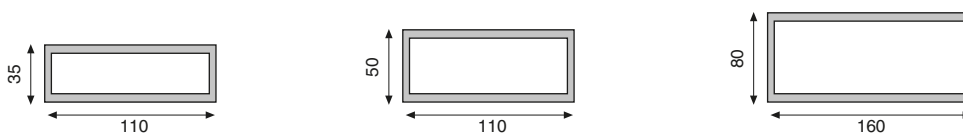

Abmessungen (mm)	35x110	50x110	80x160
Code der klebenden Etikettenhalter	<b>ETCA35-110</b>	<b>ETCA50-110</b>	<b>ETCA80-160</b>
€/Packung			
Code 1 Magnet	<b>ETCM35-110</b>	<b>ETCM50-110</b>	<b>ETCM80-160</b>
€/Packung			
Code 2 Magneten	<b>ETC2M35-110</b>	<b>ETC2M50-110</b>	<b>ETC2M80-160</b>
€/Packung			
Farbcode	<span style="color:red">01</span>	<span style="color:gray">02</span>	<span style="color:yellow">03</span> <span style="color:green">04</span> <span style="color:blue">05</span> <span style="border:1px solid black; border-radius:50%; padding:2px;">06</span>

55



Abmessungen (mm)	50x110	80x160
Code der klebenden Etikettenhalter	<b>ETUA50-110</b>	<b>ETUA80-160</b>
€/Packung		
Code 1 Magnet	<b>ETUM50-110</b>	<b>ETUM80-160</b>
€/Packung		
Code 2 Magneten	<b>ETU2M50-110</b>	<b>ETU2M80-160</b>
€/Packung		
Farbcode	<span style="color:red">01</span>	<span style="color:gray">02</span> <span style="color:yellow">03</span> <span style="color:green">04</span> <span style="color:blue">05</span> <span style="border:1px solid black; border-radius:50%; padding:2px;">06</span>



Abmessungen (mm)	60x600	80x600
Code der klebenden Etikettenhalter	<b>ETLA60-600</b>	<b>ETLA80-600</b>
€/Packung		
Code 1 Magnet	<b>ETLM60-600</b>	<b>ETLM80-600</b>
€/Packung		
Code 2 Magneten	<b>ETL2M60-600</b>	<b>ETL2M80-600</b>
€/Packung		
Farbcode	<span style="color:red">01</span>	<span style="color:gray">02</span> <span style="color:yellow">03</span> <span style="color:green">04</span> <span style="color:blue">05</span> <span style="border:1px solid black; border-radius:50%; padding:2px;">06</span>

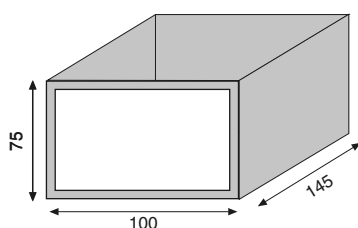

Abmessungen (mm)	100x75x145
Code klebendes Kanban	<b>KAN-PLT</b>
€/Packung	

## "C" Magnetischer Etikettenhalter



Vorderseite Rückseite Seite

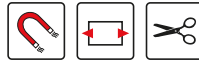
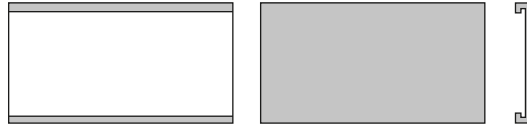

Packung: 25 Stk.

### FORMATE

56

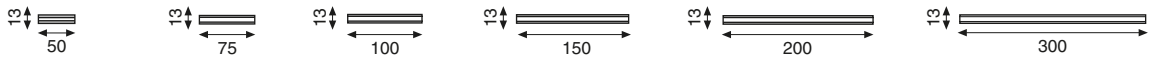

Abmessungen (mm)	13x50	13x75	13x100	13x150	13x200	13x300
Code	<b>MC13-50</b>	<b>MC13-75</b>	<b>MC13-100</b>	<b>MC13-150</b>	<b>MC13-200</b>	<b>MC13-300</b>
€/Packung						

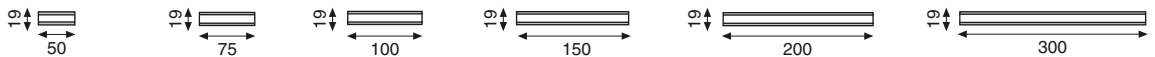

Abmessungen (mm)	19x50	19x75	19x100	19x150	19x200	19x300
Code	<b>MC19-50</b>	<b>MC19-75</b>	<b>MC19-100</b>	<b>MC19-150</b>	<b>MC19-200</b>	<b>MC19-300</b>
€/Packung						

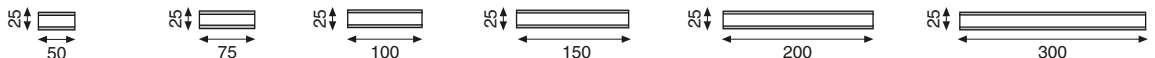

Abmessungen (mm)	25x50	25x75	25x100	25x150	25x200	25x300
Code	<b>MC25-50</b>	<b>MC25-75</b>	<b>MC25-100</b>	<b>MC25-150</b>	<b>MC25-200</b>	<b>MC25-300</b>
€/Packung						

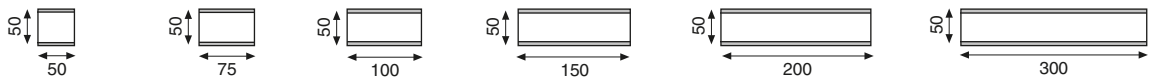

Abmessungen (mm)	50x50	50x75	50x100	50x150	50x200	50x300
Code	<b>MC50-50</b>	<b>MC50-75</b>	<b>MC50-100</b>	<b>MC50-150</b>	<b>MC50-200</b>	<b>MC50-300</b>
€/Packung						

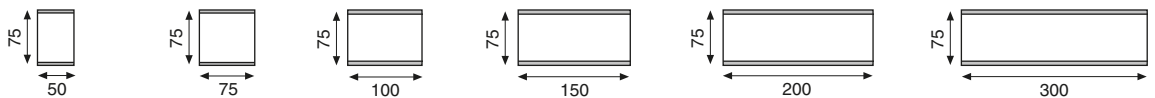

Abmessungen (mm)	75x50	75x75	75x100	75x150	75x200	75x300
Code	<b>MC75-50</b>	<b>MC75-75</b>	<b>MC75-100</b>	<b>MC75-150</b>	<b>MC75-200</b>	<b>MC75-300</b>
€/Packung						

## Klebende Magneten



Vorderseite Rückseite

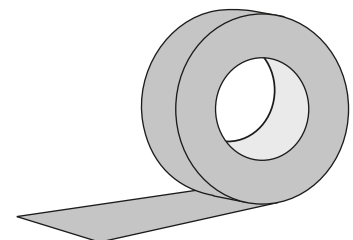

Packung: 1 Stk.

## Write On Magneten

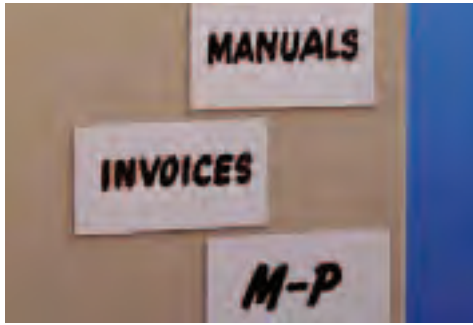

Vorderseite



Rückseite

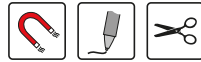

Packung: 25 Stk.

### FORMATE

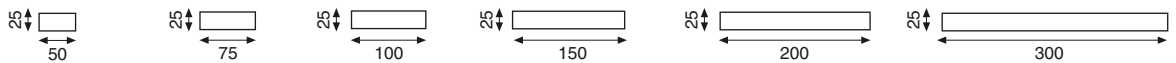

Abmessungen (mm)	25x50	25x75	25x100	25x150	25x200	25x300
Code	<b>MW25-50</b>	<b>MW25-75</b>	<b>MW25-100</b>	<b>MW25-150</b>	<b>MW25-200</b>	<b>MW25-300</b>
€/Packung						

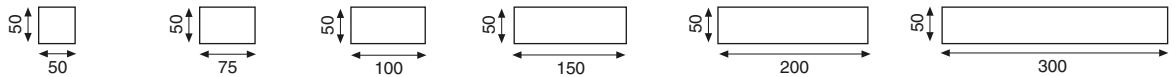

Abmessungen (mm)	50x50	50x75	50x100	50x150	50x200	50x300
Code	<b>MW50-50</b>	<b>MW50-75</b>	<b>MW50-100</b>	<b>MW50-150</b>	<b>MW50-200</b>	<b>MW50-300</b>
€/Packung						

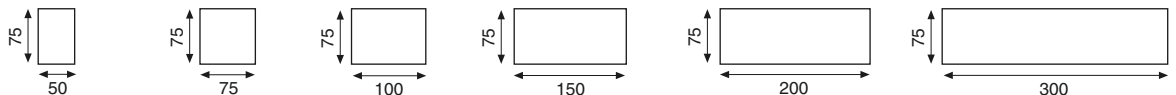

Abmessungen (mm)	13x300	19x300	25x300	50x300	75x300	75x300
Code	<b>MW75-50</b>	<b>MW75-75</b>	<b>MW75-100</b>	<b>MW75-150</b>	<b>MW75-200</b>	<b>MW75-300</b>
€/Packung						

### Klebende Magneten

Abmessungen (mm)	13x30000	25x30000	50x30000
Code	<b>MA13</b>	<b>MA25</b>	<b>MA50</b>
€/Packung			

### Marker Stifte

Artikel	Marker Stifte mit Rund-Spitze; sortierte Farben (10 Stk.)	Marker Stifte mit Meißel Spitze; sortierte Farben (10 Stk.)
Code	<b>PEN-01</b>	<b>PEN-04</b>
€/Packung		

- Magnetischer Filzstift Halter
- Magnetischer Tafelwischer

# KANBAN SYSTEM

## Kanban System

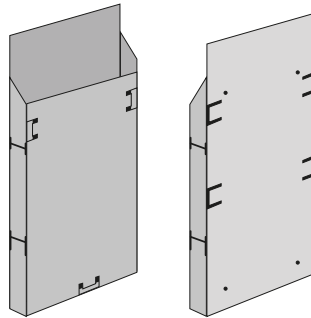

Zur Verwirklichung von Heijunka Tafeln



Ideal mit KLT oder EBOX Kanban Covers (Siehe S. 46)



Verschiedene Packungen

58

# INFOTAFELN UND TABELLEN

## Magnetische Tabellen

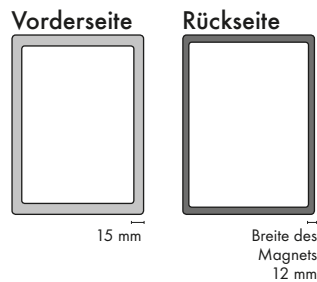

Beachten: zur Befestigung raten wir, einen klebenden Streifen hinzuzufügen



Packung: 10 Stk.

## Klebende und magnetische Tabellen

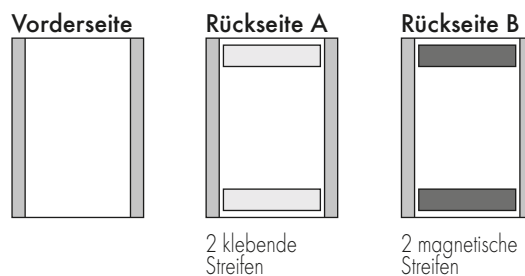

Packung: 10 Stk.

# FORMATE

Vorderer Slot

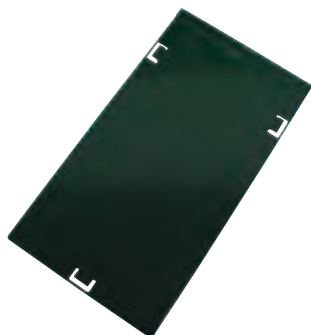

Kanban Box



Slot-Gehäuse

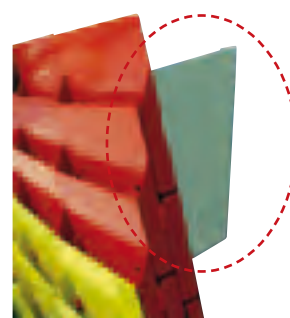

Abmessungen (mm)	175x94	210x94x Dicke 10 mm	100x50
Code	<b>KAN-FR</b>	<b>KAN-BOX</b>	<b>KAN-SUP</b>
Menge/Packung	10	28	10 Paare
€/Packung			
Farbcode	01 03 04	01 03 04	02

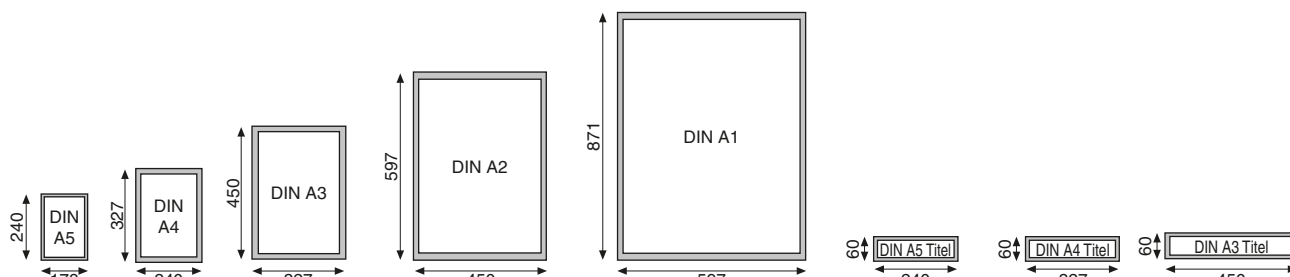

DIN Format	DIN A5	DIN A4	DIN A3	DIN A2	DIN A1	DIN A5 Titel	DIN A4 Titel	DIN A3 Titel
Code	<b>FM-A5</b>	<b>FM-A4</b>	<b>FM-A3</b>	<b>FM-A2</b>	<b>FM-A1</b>	<b>FM-A5TIT</b>	<b>FM-A4TIT</b>	<b>FM-A3TIT</b>
€/Packung								
Farbcode				01 02	03 04	05 06		

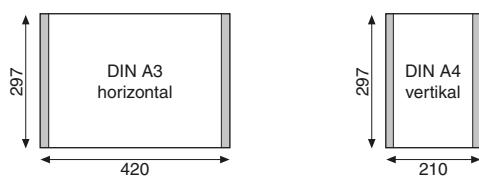

DIN Format	DIN A3 horiz.	DIN A4 vert.
Code der klebenden Tabellen	<b>F2A-A3</b>	<b>F2A-A4</b>
€/Packung		
Code der magnetischen Tabellen	<b>F2M-A3</b>	<b>F2M-A4</b>
€/Packung		
Farbcode	01 02 03 04	05 06

# INFOTAFELN UND TABELLEN

## Klebende oder magnetische Tabelle



Vorderseite



Rückseite A

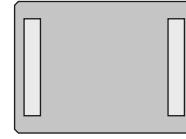

2 klebende  
Streifen

Rückseite B



2 magnetische  
Streifen

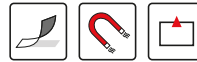

Packung: 10 Stk.

60

## Aluminium-Tabelle



Vorderseite

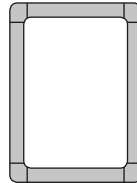

Rückseite



Packung: 1 Stk.

## Magnetische Tabelle



Vorderseite



Rückseite

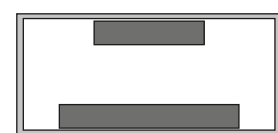

Packung: 10 Stk.

## Info – Whiteboard



Vorderseite



Packung: 1 Stk.



# FORMATE UND FARBEN

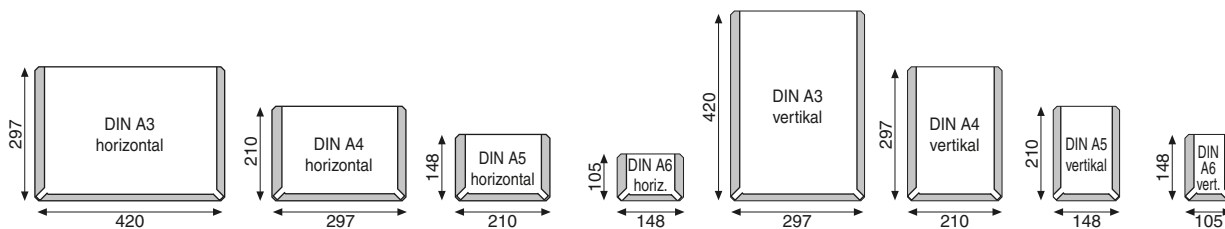

DIN Format	DIN A3 horiz.	DIN A4 horiz.	DIN A5 horiz.	DIN A6 horiz.	DIN A3 vert.	DIN A4 vert.	DIN A5 vert.	DIN A6 vert.
Code der klebenden Tabellen	<b>FA2-A30</b>	<b>FA2-A40</b>	<b>FA2-A50</b>	<b>FA2-A60</b>	<b>FA2-A3V</b>	<b>FA2-A4V</b>	<b>FA2-A5V</b>	<b>FA2-A6V</b>
€/Packung								
Code der magnetischen Tabellen	<b>FM2-A30</b>	<b>FM2-A40</b>	<b>FM2-A50</b>	<b>FM2-A60</b>	<b>FM2-A3V</b>	<b>FM2-A4V</b>	<b>FM2-A5V</b>	<b>FM2-A6V</b>
€/Packung								
Farbcode			01	02	03	04	05	06

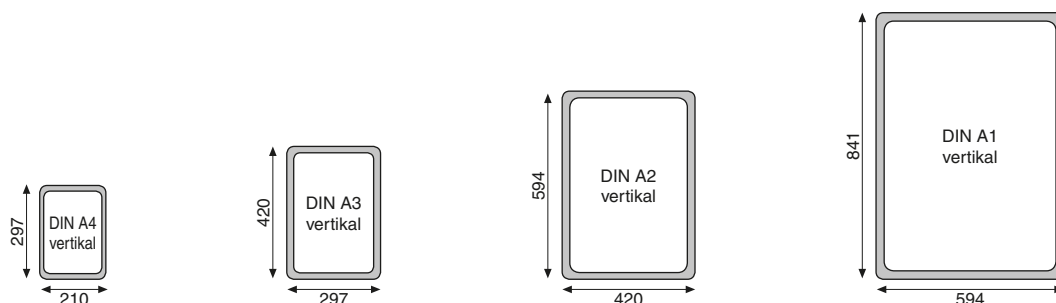

DIN Format	DIN A4 vert.	DIN A3 vert.	DIN A2 vert.	DIN A1 vert.
Code	<b>F-ALU-A4</b>	<b>F-ALU-A3</b>	<b>F-ALU-A2</b>	<b>F-ALU-A1</b>
€/Packung				

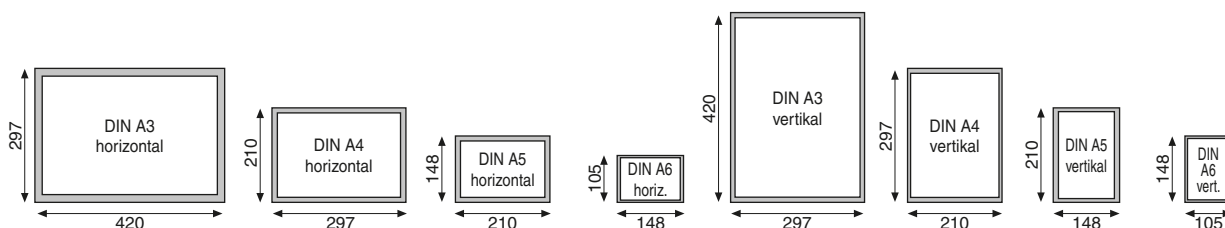

DIN Format	DIN A3	DIN A4	DIN A5	DIN A6	DIN A3	DIN A4	DIN A5	DIN A6
Code	<b>FM2-A30</b>	<b>FM2-A40</b>	<b>FM2-A50</b>	<b>FM2-A60</b>	<b>FM2-A3V</b>	<b>FM2-A4V</b>	<b>FM2-A5V</b>	<b>FM2-A6V</b>
€/Packung								

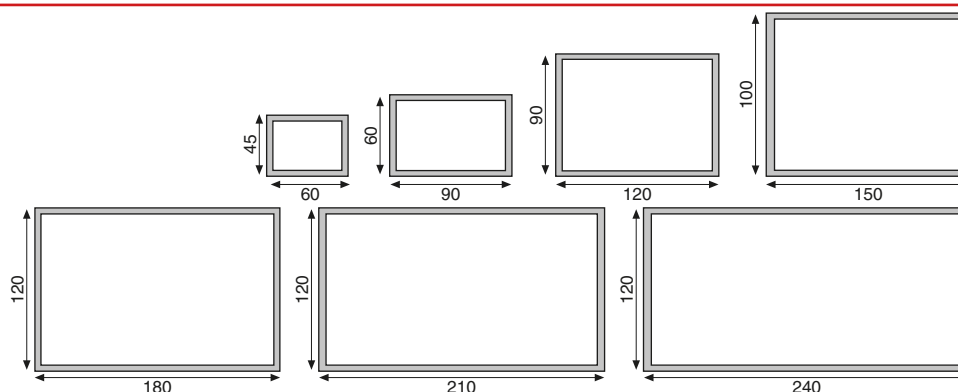

Abmessungen (cm)	45x60	60x90	90x120	100x150	120x180	120x210	120x240
Code	<b>LM45-60</b>	<b>LM60-90</b>	<b>LM90-120</b>	<b>LM100-150</b>	<b>LM120-180</b>	<b>LM120-210</b>	<b>LM120-240</b>
€/Packung							

## Klebende Kennzeichnungssymbole



NP50-L



NP75-L

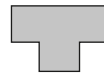

NP50-T

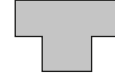

NP75-T



NP50-250



NP75-350



NP50-Q



NP75-Q



NP50-P



NP50-V



NP50-A



LET-LETTERA



NUM-NUMERO



Packung: 50 Stk.

### FORMATE

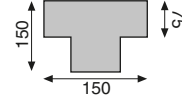
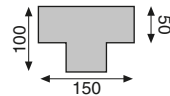
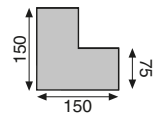
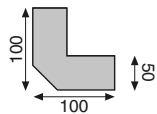

Abmessungen (mm)	50	75	50	75	50
Code	<b>NP50-L</b>	<b>NP75-L</b>	<b>NP50-T</b>	<b>NP75-T</b>	<b>NP50-P</b>
€/Packung					
Farbcode	01	02	03	04	05
				06	07
					08
					09
					10

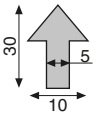
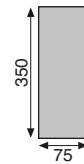
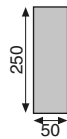

Abmessungen (mm)	50	75	50x250	75x350	50	30x10x5
Code	<b>NP50-Q</b>	<b>NP75-Q</b>	<b>NP50-250</b>	<b>NP75-350</b>	<b>NP50-V</b>	<b>NP50-A</b>
€/Packung						
Farbcode	01	02	03	04	05	06
				07	08	09
						10

### Klebende Buchstaben

# ABC

Abmessungen (mm)	80
Code	<b>LET80-LETTERA</b>
€/Packung	

### Klebende Zahlen

# 123

Abmessungen (mm)	80
Code	<b>NUM80-NUMERO</b>
€/Packung	

Auf Anfrage:  
personalisierte Symbole

## Klebende Symbole



Packung: 1 Stk.

### FORMATE

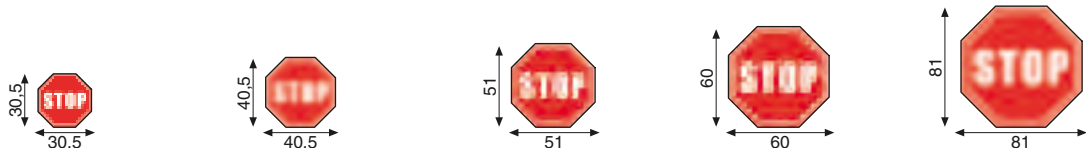

Abmessungen (cm)	Polygon 30,5	Polygon 40,5	Polygon 51	Polygon 60	Polygon 81
Code	<b>PS30,5</b>	<b>PS40,5</b>	<b>PS51</b>	<b>PS60</b>	<b>PS81</b>
€/Packung					

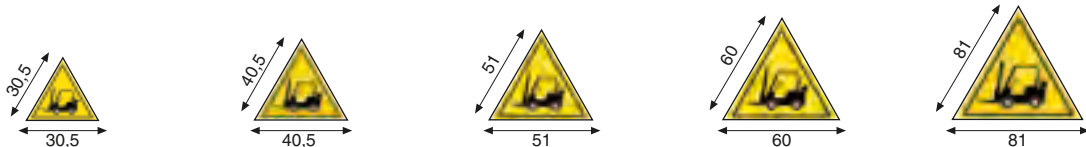

Abmessungen (cm)	Dreieck 30,5	Dreieck 40,5	Dreieck 51	Dreieck 60	Dreieck 81
Code	<b>TS30,5</b>	<b>TS40,5</b>	<b>TS51</b>	<b>TS60</b>	<b>TS81</b>
€/Packung					



Abmessungen (cm)	Kreis 30,5	Kreis 40,5	Kreis 51	Kreis 60	Kreis 81
Code	<b>CS30,5</b>	<b>CS40,5</b>	<b>CS51</b>	<b>CS60</b>	<b>CS81</b>
€/Packung					

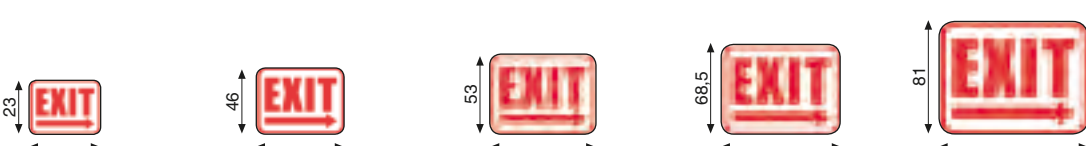

Abmessungen (cm)	Rechteck 30,5x23	Rechteck 60x46	Rechteck 76x53	Rechteck 91,5x68,5	Rechteck 81x147
Code	<b>RS30,5</b>	<b>RS60</b>	<b>RS76</b>	<b>RS91,5</b>	<b>RS81</b>
€/Packung					

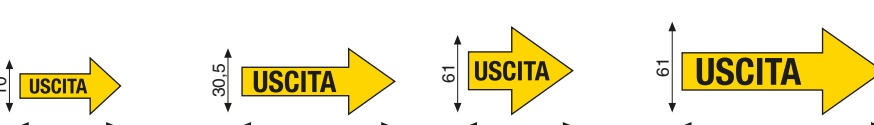

Abmessungen (cm)	Pfeil 30,5x10	Pfeil 86,5x30,5	Pfeil 61x61	Pfeil 91,5x61
Code	<b>AS30,5</b>	<b>AS86,5</b>	<b>AS61</b>	<b>AS91,5</b>
€/Packung				

## Klebende Symbole



ERHÄLTlich

64



Für weitere oder personalisierte Symbole setzen Sie sich mit unserem Verkaufsbüro in Verbindung;  
Boden-Symbole sind in Formaten von S. 63 erhältlich.



## Anwendungen



65



# BODENMARKIERUNG

## Einfarbige Bodenmarkierungsbänder

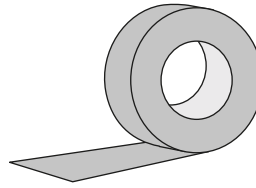

Packung: 1 Stk.

66

## Zweifarbige und personalisierbare Bodenmarkierungsbänder

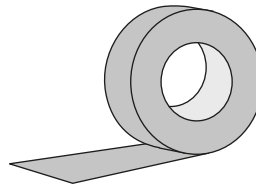
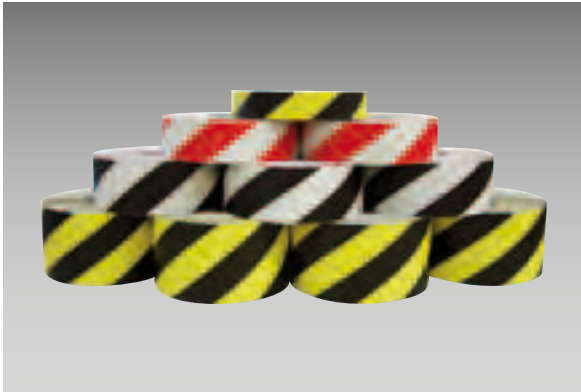

**Zur Personalisierung:  
Mindestauftrag 3 Rollen + 50 € für  
den Dienst**



Packung: 1 Stk.

## Extrastarke Bodenmarkierungsbänder

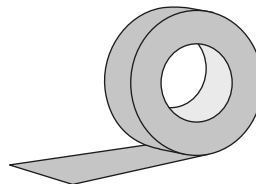

**Extrastarkes Gafferband**



Packung: 1 Stk.

## FORMATE UND FARBEN

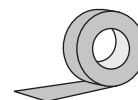
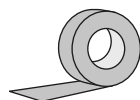
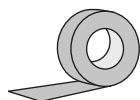

Abmessungen (mm)	30000x50 (30 m)	30000x75 (30 m)	30000x100 (30 m)
Code	<b>NP50</b>	<b>NP75</b>	<b>NP100</b>
€/Packung			
Farbcode	01 02 03 04 05 06 07 08 09 10		

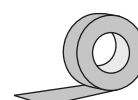
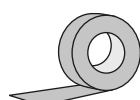
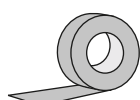

Abmessungen (mm)	30000x50 (30 m)	30000x75 (30 m)	30000x100 (30 m)
Code zweifarb. Bänder	<b>NPB50</b>	<b>NPB75</b>	<b>NPB100</b>
€/Packung			
Code personalis. Bänder	<b>NPP50</b>	<b>NPP75</b>	<b>NPP100</b>
€/Packung			
Farbcode	Gelb/Schwarz  Weiß/Schwarz  Weiß/Rot		

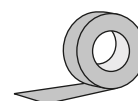
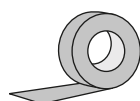
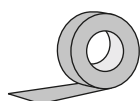

Abmessungen (mm)	30000x50 (30 m)	30000x75 (30 m)	3000x100
Code	<b>NPS50</b>	<b>NPS75</b>	<b>NPS100</b>
€/Packung			
Farbcode	01 02 03 04 05 06 07 08 09 10		



# INFO-RAHMEN

## Info-Rahmen



Vorderseite

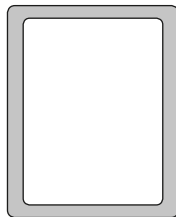

Rückseite

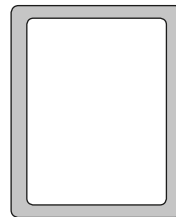

## FORMATE UND ZUBEHÖR

68

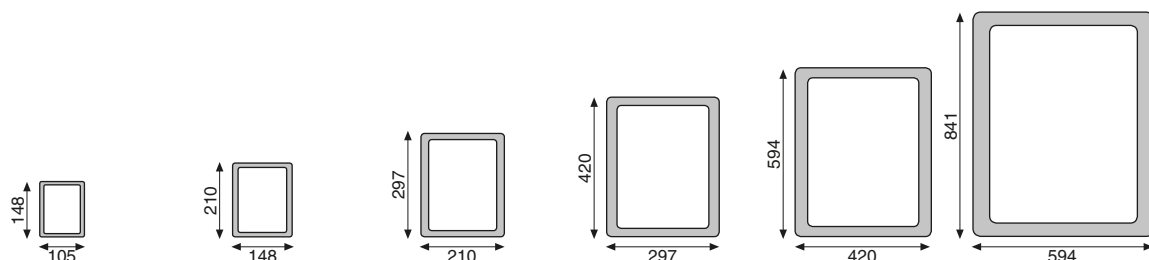

Code	<b>CRN A6</b>	<b>CRN A5</b>	<b>CRN A4</b>	<b>CRN A3</b>	<b>CRN A2</b>	<b>CRN A1</b>
Packung	10 Stk.	10 Stk.	10 Stk.	10 Stk.	5 Stk.	5 Stk.
€/Packung						

## ZUBEHÖR

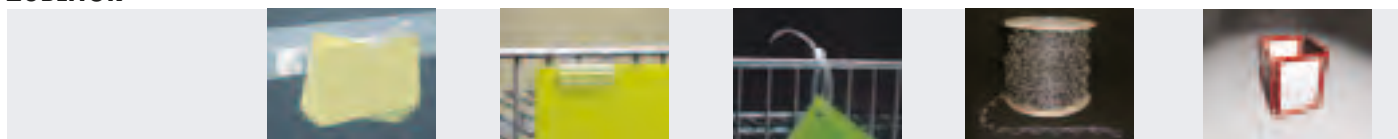

Code	<b>GN-03</b>	<b>GN-04</b>	<b>GN-05</b>	<b>GN-07</b>	<b>GN-08</b>
Packung	100 Stk.	100 Stk.	100 Stk.	1 Rolle 30 m	20 Stk.
€/Packung					

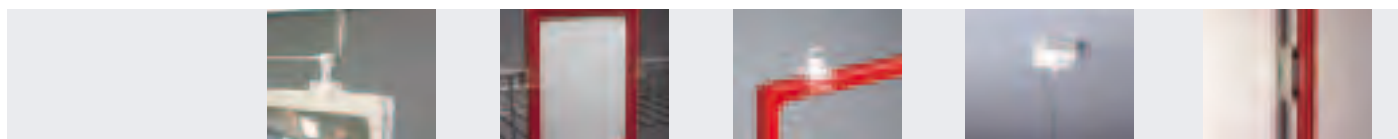

Code	<b>GN-09</b>	<b>GN-10</b>	<b>GN-11</b>	<b>GN-12</b>	<b>GN-13</b>
Packung	50 Stk.	20 Stk.	20 Stk.	10 Stk.	10 Stk.
€/Packung					



Code	<b>GN-14</b>	<b>GN-15</b>	<b>GN-16</b>	<b>GN-17</b>	<b>GN-18</b>
Packung	10 Stk.	20 Stk.	50 Stk.	20 Stk.	20 Stk.
€/Packung					

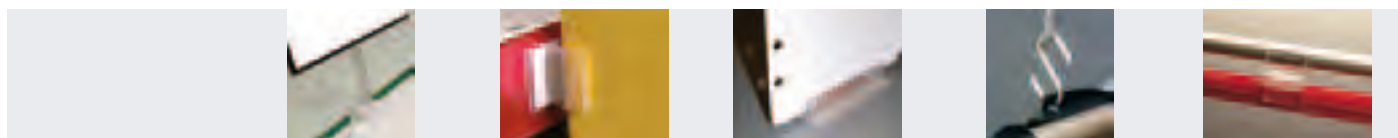

Code	<b>GN-19</b>	<b>GN-20</b>	<b>GN-21</b>	<b>GN-22</b>	<b>GN-23</b>
Packung	20 Stk.	100 Stk.	100 Stk.	50 Stk.	20 Stk.
€/Packung					