



UTEK

Lean Production Division



ALUMINIUM
MODULARES SYSTEM

www.utekvision.de

: ultraleicht, einfache Montage

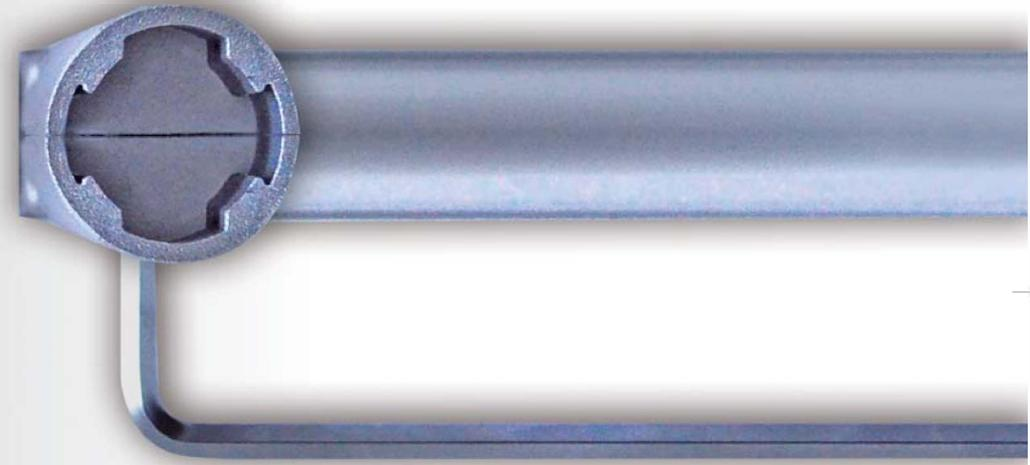

ALUMINIUM MODULARES SYSTEM: KOMPONENTEN

ALUMINIUM ROHR

ASP-1120 ALUMINIUM STANDARD PIPE 1.2T

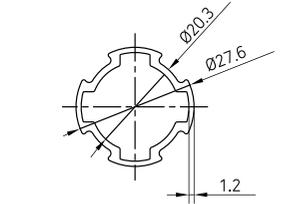
▪ 1.388kgs/4mts

ASP-1200 ALUMINIUM STANDARD PIPE 2.0T

▪ 1.660kgs/4mts

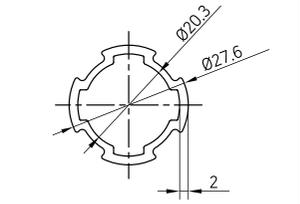
ASP-1280 ALUMINIUM STANDARD PIPE 2.8T

▪ 1.904kgs/4mts

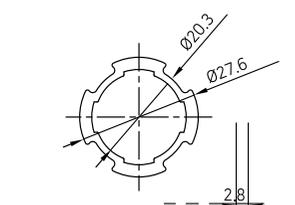
ADP-1120 ALUMINIUM DOUBLE PIPE 1.2T

▪ 2.880kgs/4mts

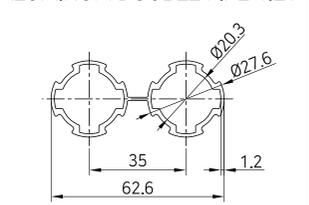
ADP-1120W ALUMINIUM DOUBLE WIDE PIPE 1.2T

▪ 4.144kgs/4mts

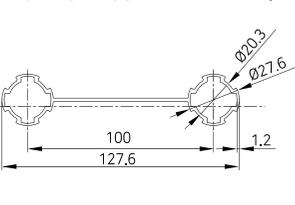
ACP-1120 ALUMINIUM CIRCLE PIPE 1.2T

▪ 1.628kgs/4mts

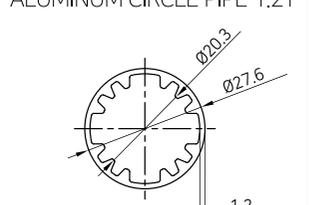
ALP-1120 ALUMINIUM L TYPE PIPE 1.2T

▪ 2.332kgs/4mts

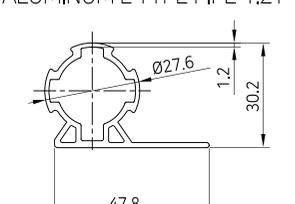
ATP-1270 ALUMINIUM T TYPE PIPE 2.7T

▪ 2.420kgs/4mts

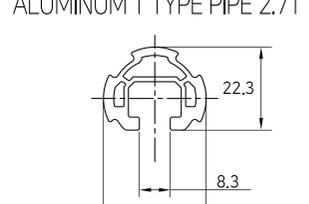

ALUMINIUM MODULARES SYSTEM: KOMPONENTEN

ALUMINIUMVERBINDER- INDIVIDUELL

AJ-01



■ 25gms/pc

AJ-01B



■ 16.8gms/pc

AJ-01C



■ 25.3gms/pc

AJ-03



■ 67.3gms/pc

AJ-04



■ 61.3gms/pc

AJ-05



■ 15.8gms/pc

AJ-05A



■ 13.4gms/pc

AJ-06



■ 30.9gms/pc

AJ-06A



■ 32gms/pc

AJ-07



■ 13.6gms/pc

AJ-08

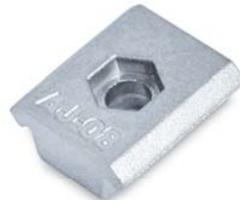

■ 11.4gms/pc

AJ-08A



■ 11.4gms/pc

AJ-08W



■ 28.9gms/pc

AJ-09



■ 47.4gms/pc

AJ-13



■ 47.5gms/pc

ALUMINIUM MODULARES SYSTEM: KOMPONENTEN

ALUMINIUMVERBINDER- INDIVIDUELL



ALUMINIUM MODULARES SYSTEM: KOMPONENTEN

ALUMINIUMVERBINDER

AJA-01

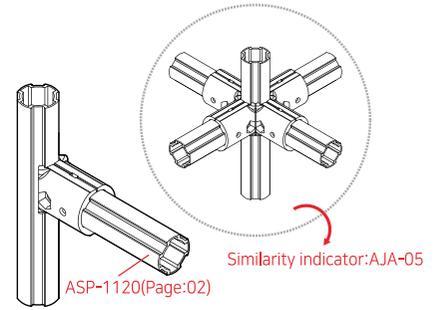
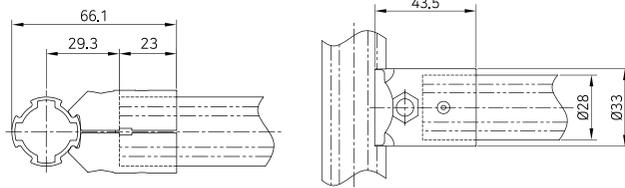

- The combination breakdown
AJ-01 : 2pcs / Bolt(BT-0625) : 1pc / Nut(NT-0600) : 1pc

6

AJA-01B

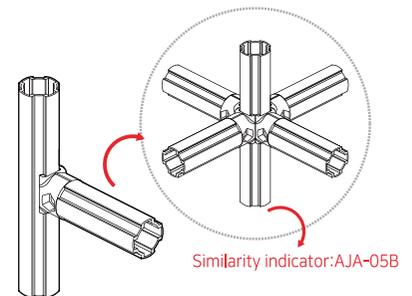
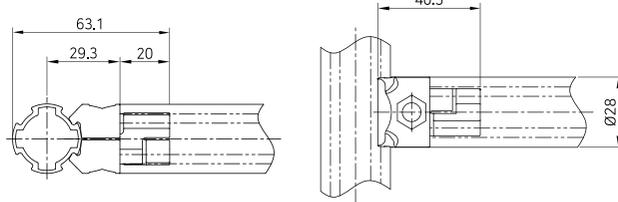

- The combination breakdown
AJ-01B: 2pcs / Bolt(BT-0620) : 1pc / Nut(NT-0600) : 1pc

AJA-01C

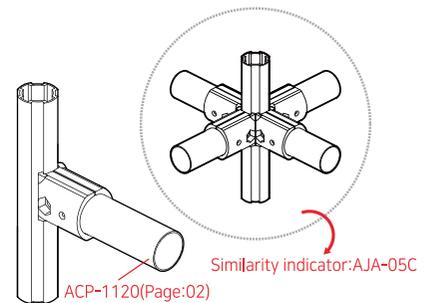
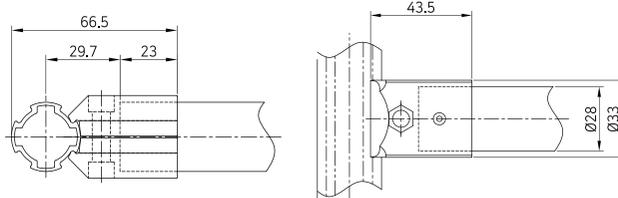

- The combination breakdown
AJ-01C : 2pcs / Bolt(BT-0625) : 1pc / Nut(NT-0600) : 1pc

AJA-03

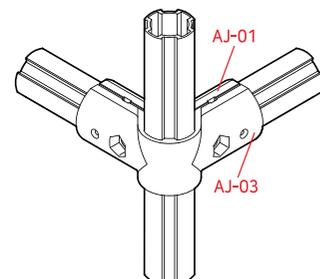
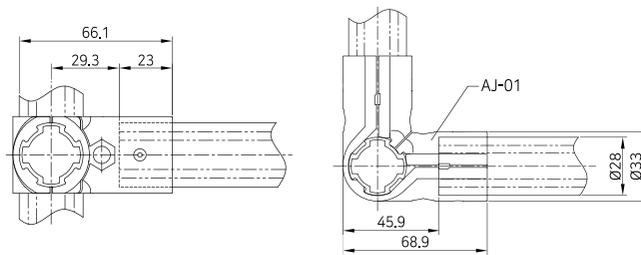

- The combination breakdown
AJ-01: 2pcs / AJ-03 : 1pc / Bolt(BT-0625) : 2pcs / Nut(NT-0600) : 2pcs

ALUMINIUM MODULARES SYSTEM: KOMPONENTEN

ALUMINIUMVERBINDER

AJA-04

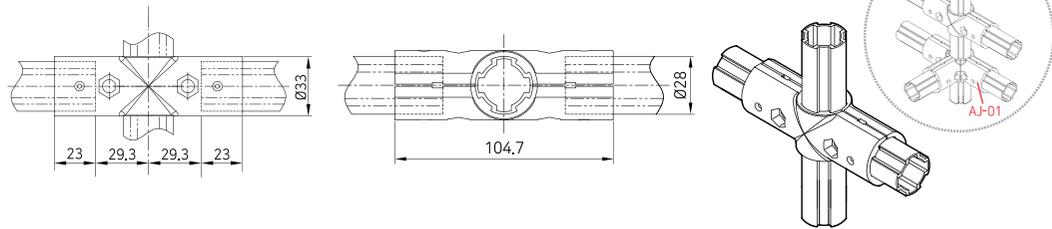

- The combination breakdown
AJ-04 : 2pcs / Bolt(BT-0625) : 2pcs / Nut(NT-0600) : 2pcs

AJA-05

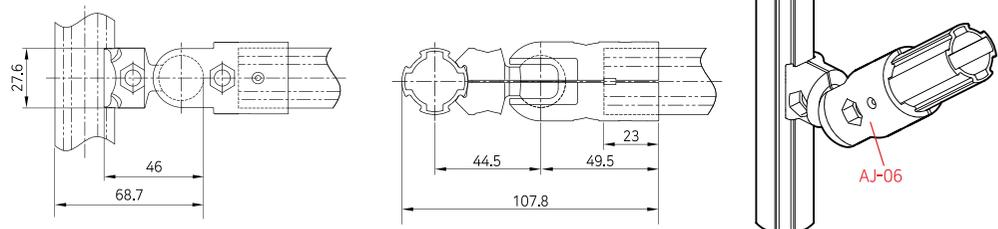

- The combination breakdown
AJ-05 : 2pcs / AJ-06 : 2pcs / Bolt(BT-0620) : 1pc / Bolt(BT-0625) : 1pc / Nut(NT-0600) : 2pcs

AJA-05A

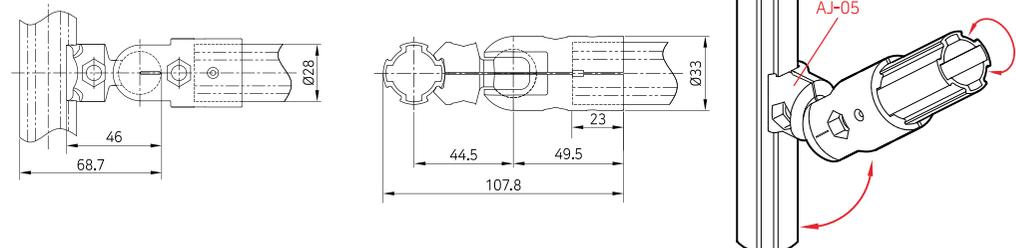

- The combination breakdown
AJ-05 : 2pcs / AJ-06A : 2pcs / Bolt(BT-0625) : 1pc / Bolt(BT-0620) : 1pc / Nut(NT-0600) : 2pcs

AJA-06

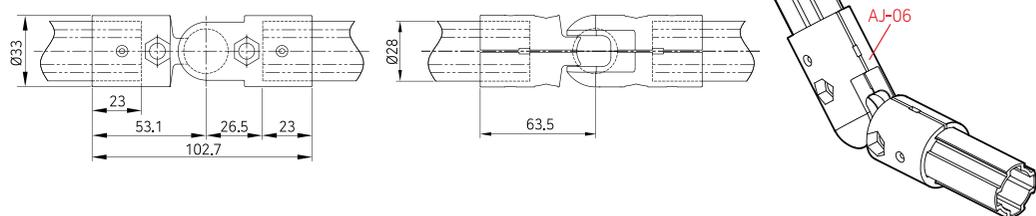

- The combination breakdown
AJ-05A : 2pcs / AJ-06 : 2pcs / Bolt(BT-0625) : 2pcs / Nut(NT-0600) : 2pcs

(alle oben gezeigten Gewichte beziehen sich auf das jeweilige Produkt)

ALUMINIUM MODULARES SYSTEM: KOMPONENTEN

ALUMINIUMVERBINDER

AJA-06A

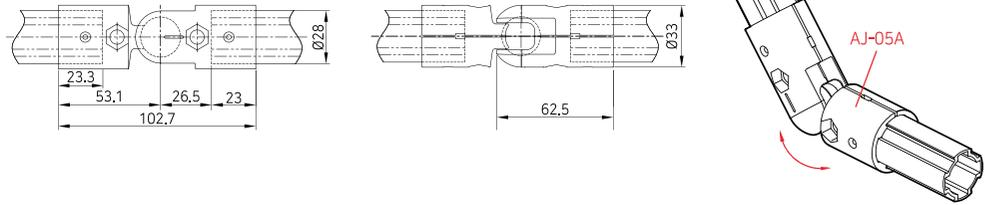

- The combination breakdown
AJ-05A : 2pcs / AJ-06 A: 2pcs / Bolt(BT-0625) : 2pcs / Nut(NT-0600) : 2pcs

8

AJA-07

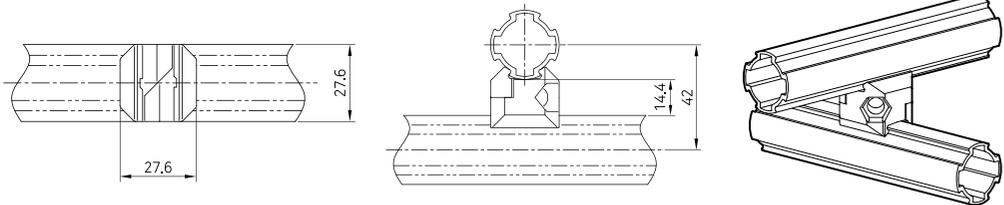

- The combination breakdown
AJ-07 : 2pcs / Bolt(BT-0625) : 1pc / Nut(NT-0600) : 1pc

AJA-08

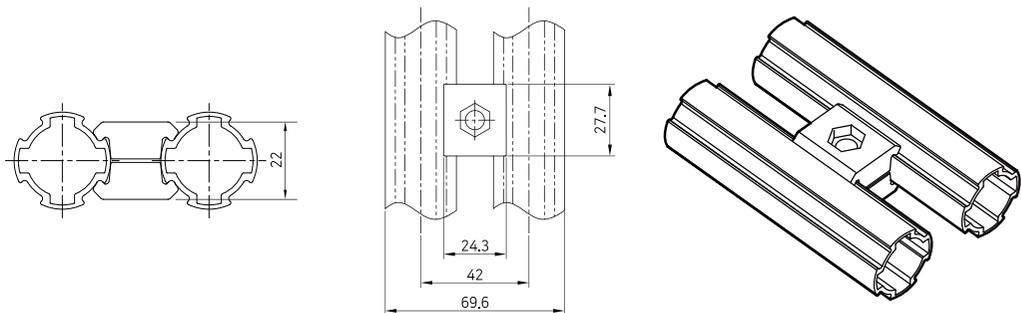

- The combination breakdown
AJ-08 : 2pcs / Bolt(BT-0620) : 1pc / Nut(NT-0600) : 1pc

AJA-08A

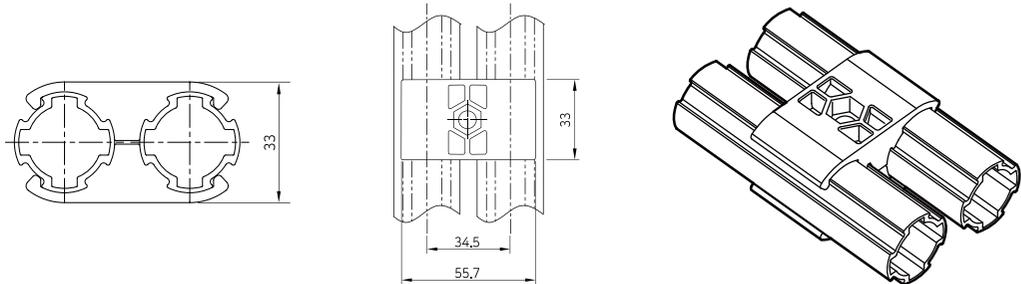

- The combination breakdown
AJ-08A : 2pcs / Bolt(BT-0625) : 1pc / Nut(NT-0600) : 1pc

ALUMINIUM MODULARES SYSTEM: KOMPONENTEN

ALUMINIUMVERBINDER

AJA-08W

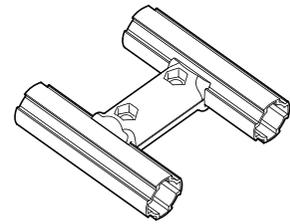
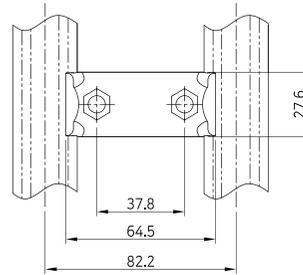
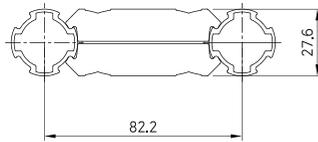

- The combination breakdown
AJ-08W : 2pcs / Bolt(BT-0620) : 2pcs / Nut(NT-0600) : 2pcs

AJA-09

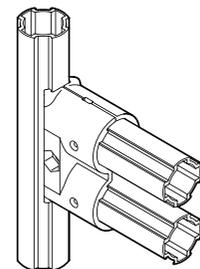
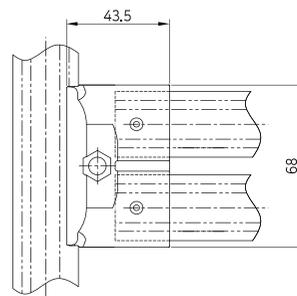
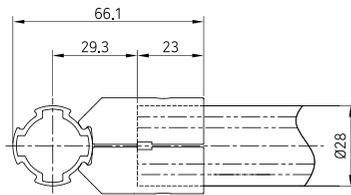

- The combination breakdown
AJ 09 2 pcs / Bolt(BT 0625) 1 pc / Nut(NT 0600) 1 pc

AJA-13

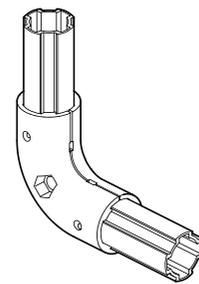
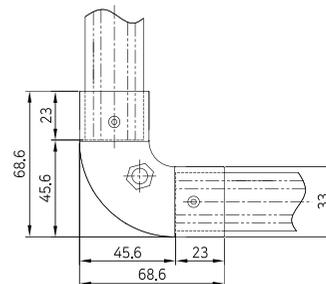
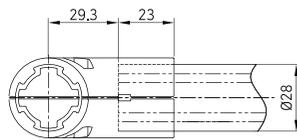

- The combination breakdown
AJ-13 : 2pcs / Bolt(BT-0625) : 1pc / Nut(NT-0600) : 1pc

AJA-13B

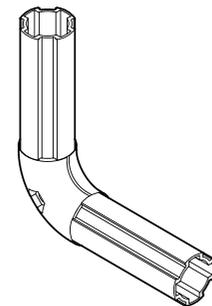
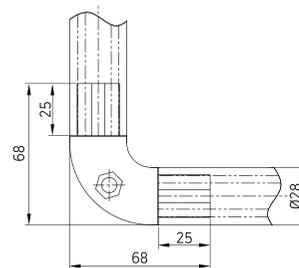
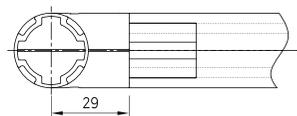

- The combination breakdown
AJ-13B : 2pcs / Bolt(BT-0620) : 1pc / Nut(NT-0600) : 1pc

(alle oben gezeigten Gewichte beziehen sich auf das jeweilige Produkt)

ALUMINIUM MODULARES SYSTEM: KOMPONENTEN

ALUMINIUMVERBINDER

AJA-45R/AJA-45L

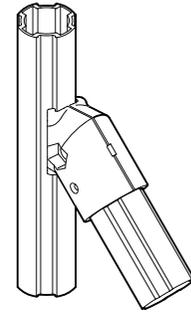
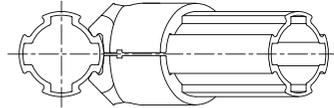
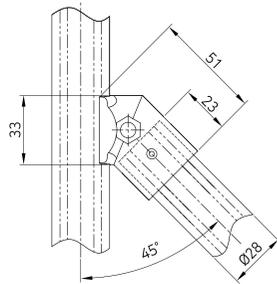

- The combination breakdown
AJ-45L : 1pc / AJ-45R : 1pc / Bolt(BT-0625) : 1pc / Nut(NT-0600) : 1pc

10

AJA-45W

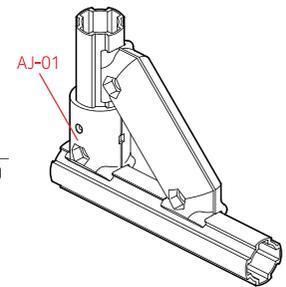
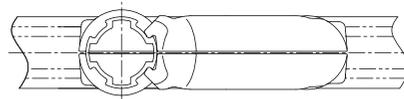
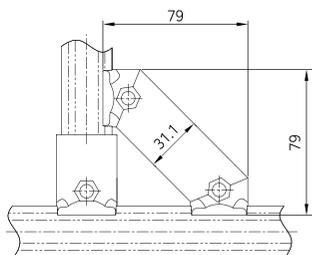

- The combination breakdown
AJ-45W : 2pcs / Bolt(BT-0620) : 2pcs / Nut(NT-0600) : 2pcs

ACS-70

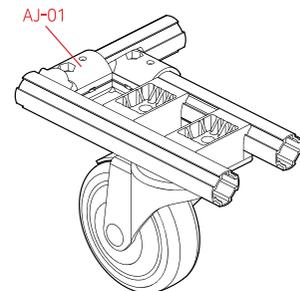
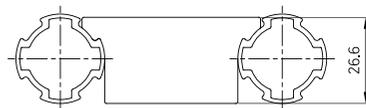
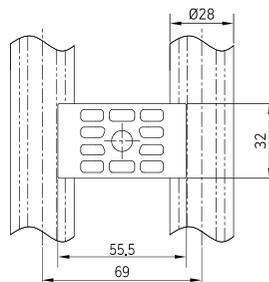

- The combination breakdown - ACS-70 : 1pc / Bolt(BT-0835) : 1pc / Nut(NT-0800) : 1pc

(alle oben gezeigten Gewichte beziehen sich auf das jeweilige Produkt)

ALUMINIUM MODULARES SYSTEM: KOMPONENTEN

ZUBEHÖR

ARC-55

ALUMINIUM RAIL FRAME COVER ■ 1.280kgs/4mts

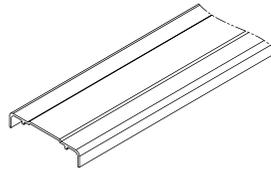
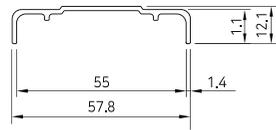

ARF-2815

ALUMINIUM RAIL FRAME 1.5T

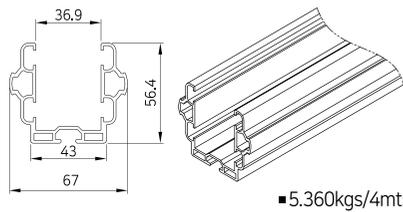

■ 5.360kgs/4mts

ARF-2820

ALUMINIUM RAIL FRAME 2.0T

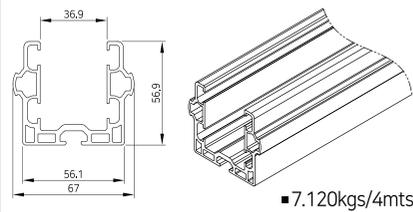

■ 7.120kgs/4mts

ALR-404

LINEAR ROLLER ■ 16.7gms/pc

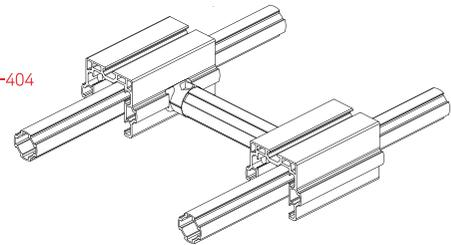
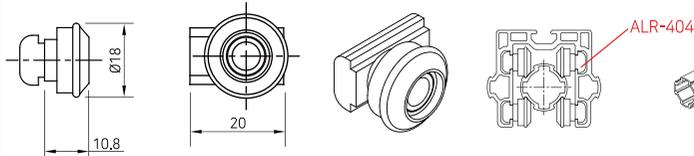

■ The combination breakdown
SN - 404 & IN - 404 : 1pc(ea) / BT - 0412 & BT - 0415 : 1pc(ea)

APH-2820

ALUMINIUM PANEL HOLDER ■ 3.600kgs/4mts (0.018kgs/20mm)

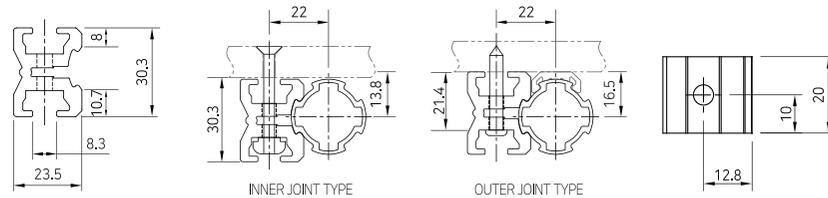

INNER JOINT TYPE

OUTER JOINT TYPE

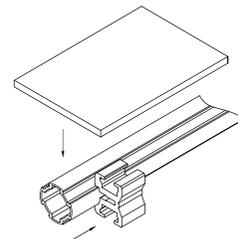

ASH-2852

ALUMINIUM SLEEVE HINGE ■ 35.1gms/pc

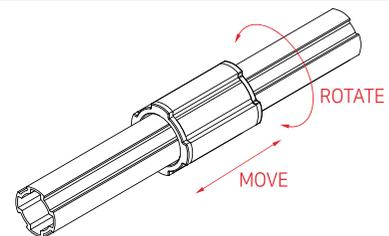
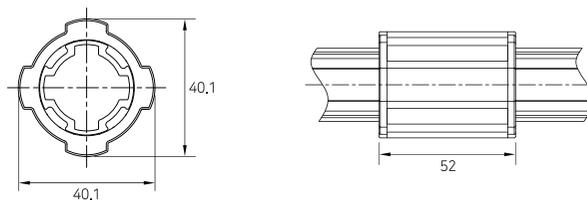

■ The combination breakdown
ACS - 40A : 2pcs / ASF - 2846A(46mm) : 1pc

ALUMINIUM MODULARES SYSTEM: KOMPONENTEN

ZUBEHÖR

APJ-110T ALUMINIUM T TYPE PIPE INNER CAP

■ 1.4gms/pc

APJ-110S ALUMINIUM STANDARD TYPE PIPE INNER CAP

■ 2.1gms/pc

ALUMINIUM PIPE INSERT NUT AIN-2812A / AIN-2812B

PROJECT CODE	"X"
AIN-2812A	1/2" TAP
AIN-2812B	M12 TAP

■ 18.1gms/pc

ATR-6 ALUMINIUM T SLIDE ROLLER

■ 31.4gms/pc

O.D.(Outer Diameter) / I.D.(Inner Diameter)

SPRING NUT SN-403/404/405/406/408

■ 9gms/pc

INSERT NUT IN-403/404/405/406/408

■ 10gms/pc

ASG-5A ALUMINIUM SHEET GUIDE

■ 0.676kgs/4mts

AH-0175 ALUMINIUM HANDLE

Set : AH-0175 : 1pc
AJ-08 : 2pcs
Bolt(BT-0620) : 2pcs
Nut(NT-0600) : 2pcs

■ 48.5gms/pc

APC-1 ALUMINIUM PIPE COVER

■ 0.213kgs/3mts

ALUMINIUM MODULARES SYSTEM: KOMPONENTEN

ZUBEHÖR

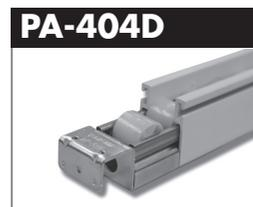
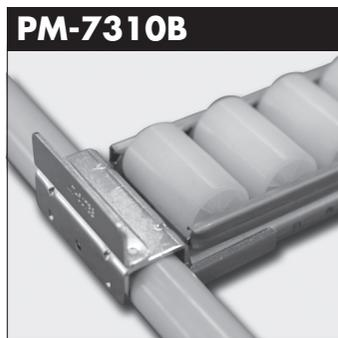
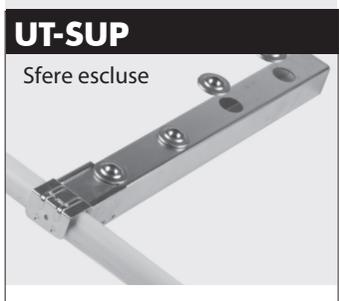
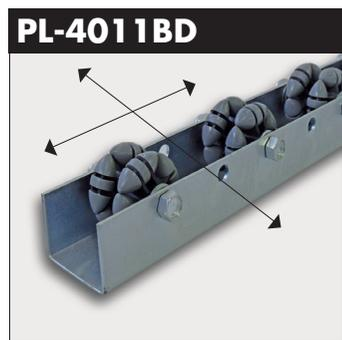
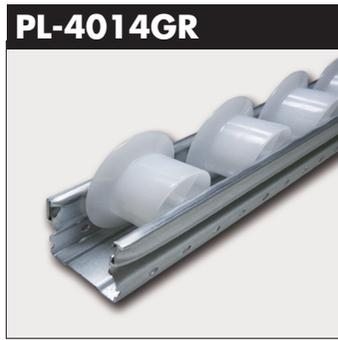

ALUMINIUM MODULARES SYSTEM: TEILELEGENDE

14

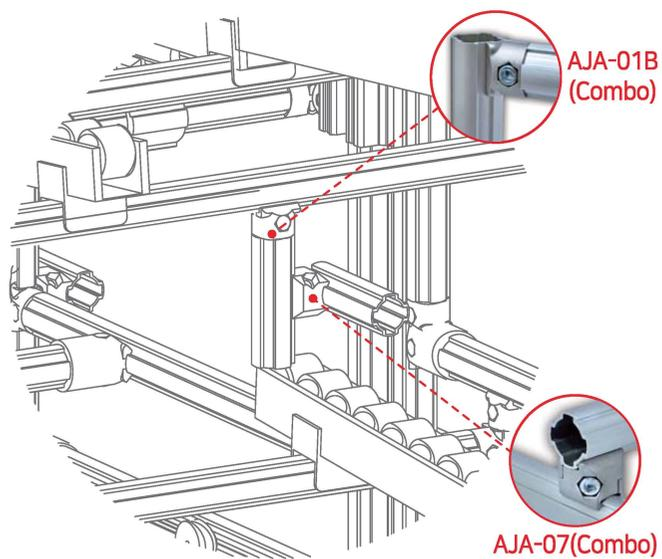
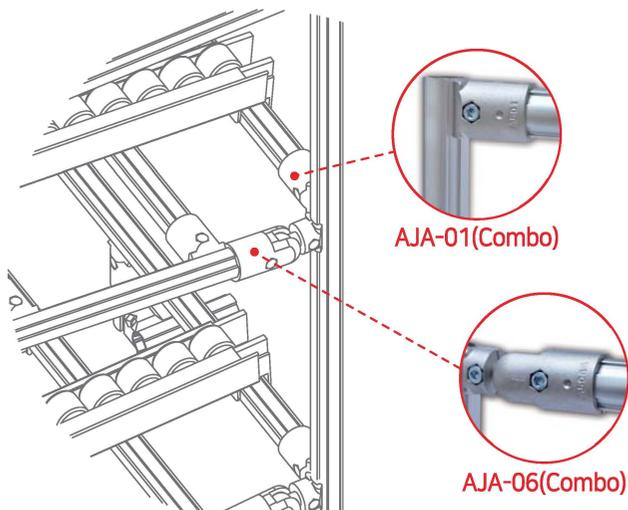

Excellent scalability to
integrate with the AGV
technology



ALUMINIUM MODULARES SYSTEM: TEILELEGENDE

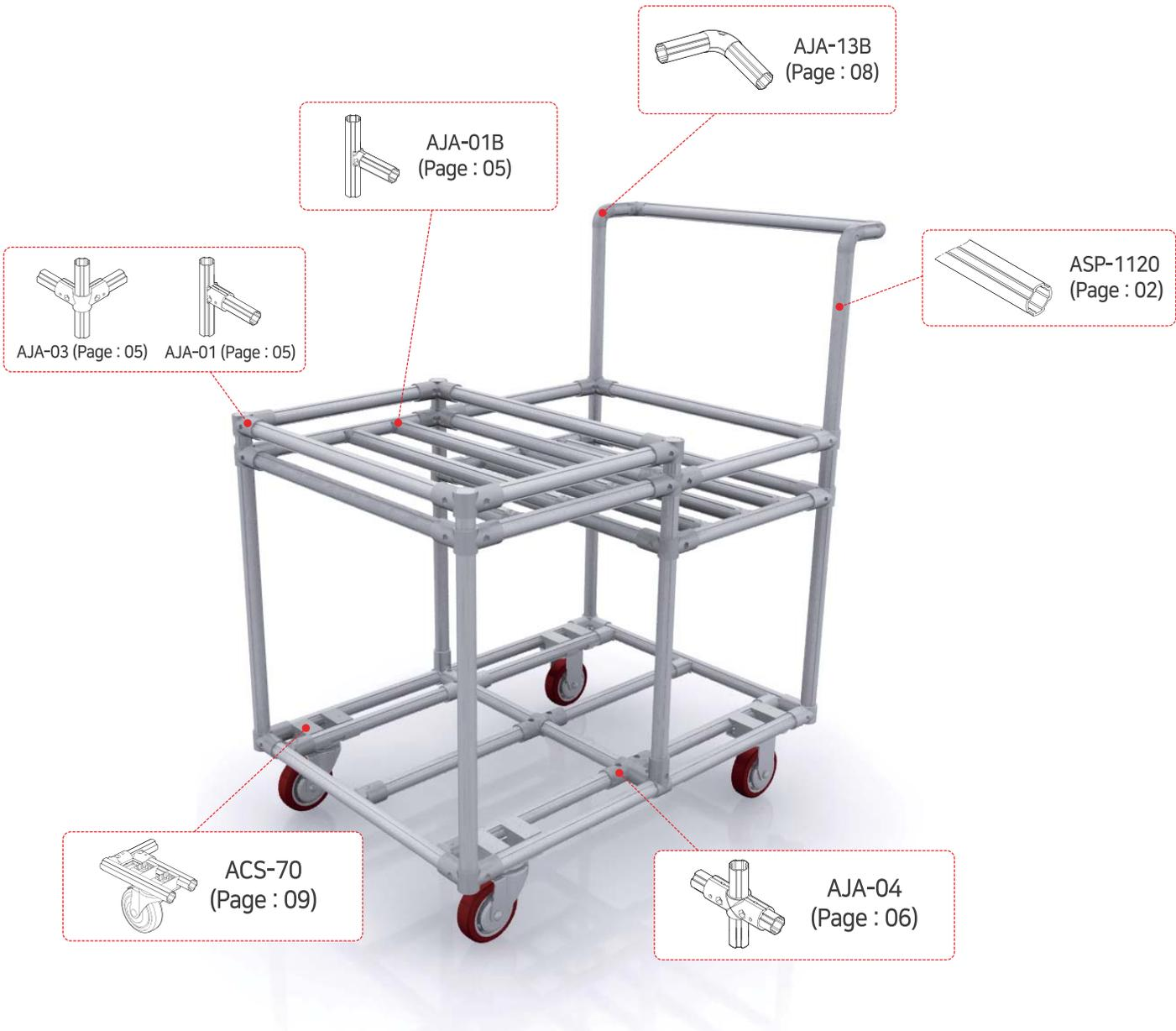



Utek srl - Via Luciano Lama, 8 - Villa Argine
42023 Cadelbosco di Sopra (RE) - Italy
Tel. +39.0522.958945 - Fax +39.0522.912181
infoutekvision.com - www.utekvision.com

Utek Deutschland - Germany
kontakt@utekvision.de - www.utekvision.de